

Danielson®

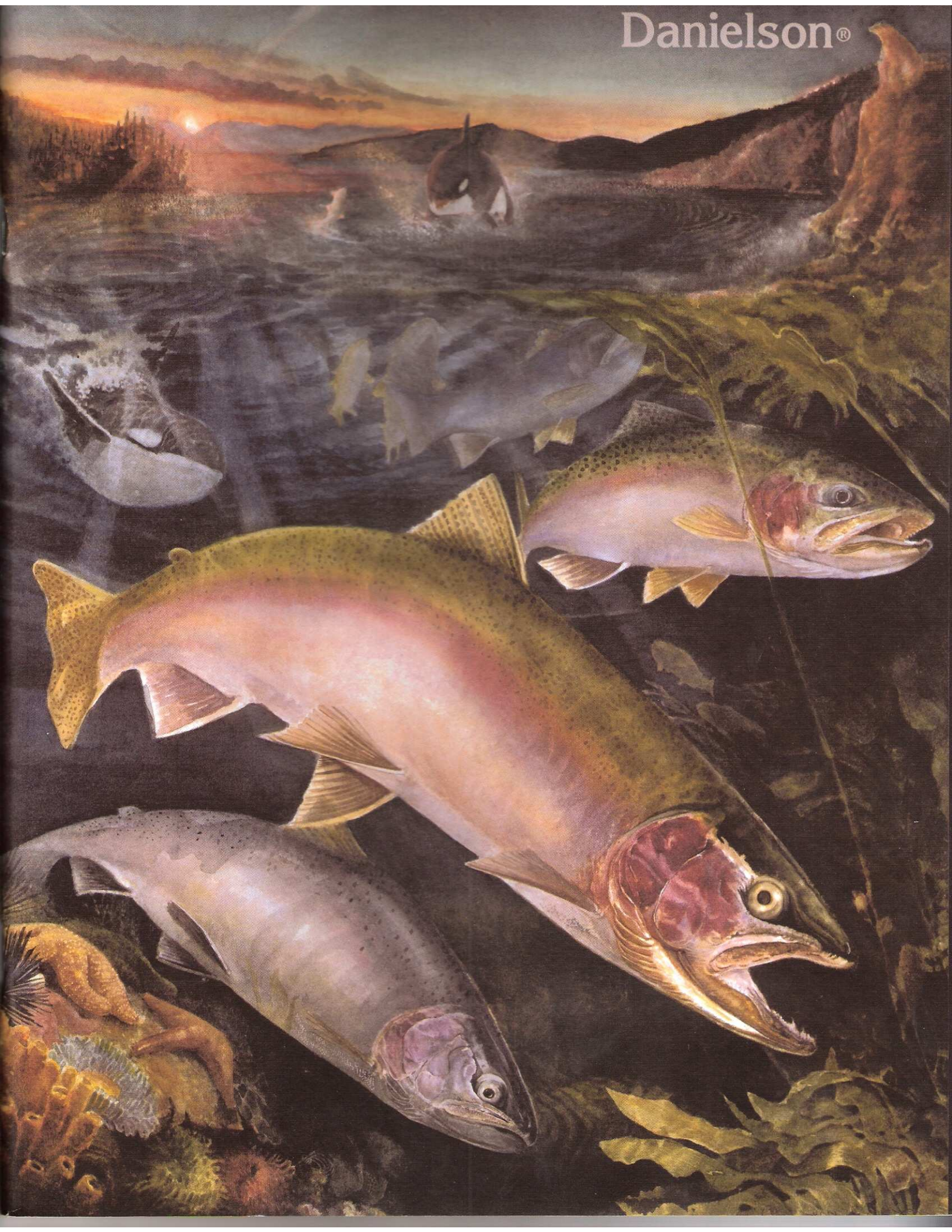
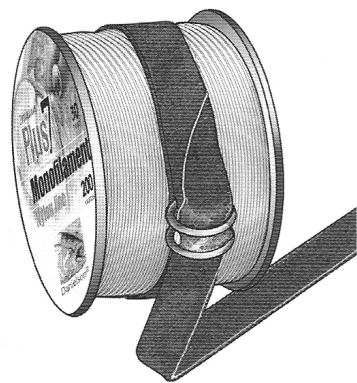

TABLE OF CONTENTS

A					
Aerators.....	27				
Anchors.....	44				
Anchor Pulley.....	43				
B					
Bag, Commercial Fish.....	32				
Bait Boxes.....	36				
Bait Containers, Crab.....	47				
Bait Cutting Board.....	37				
Bait Cutting Guide.....	37				
Bait Nets.....	30				
Bait Scoop.....	30				
Bait Syringe.....	36				
Bait Threaders.....	36				
Baits, Vinyl.....	21				
Baskets, Wire.....	27				
Beads.....	14, 18				
Bells.....	34				
Belt, Wader.....	32				
Bobbers.....	14, 17, 23				
Bobbers, Ice.....	41				
Bobber Stops.....	14				
Boot Hangers.....	32				
Bow Chock.....	43				
Buckets, Bait.....	27				
Buoys.....	34				
C					
Chum Bag.....	47				
Clam Guns.....	49				
Clam Net.....	49				
Clam Rakes.....	49				
Clam Shovels.....	49				
Cleats, Ice.....	41				
Clippers, Line.....	38				
Club, Fish Billie.....	30				
Compass, Pin-On.....	43				
Cord Locks.....	42				
Cord, Utility.....	43				
Crab Nets.....	46				
Crab Traps.....	45, 47, 48				
Crabbing Gear & Accessories.....	47, 49				
Crayfish Trap.....	26				
Creel Harness.....	32				
Creels.....	32				
Cricket Containers.....	26				
Crimps, Line.....	42				
Cutters, Line.....	38				
D					
Decoy Anchor Weights.....	43				
Decoy Cords.....	42				
Depth Adjusters.....	42				
Depth & Temperature Gauge.....	41				
Depthfinder Weights.....	41				
Dial Box Assortments.....	18				
Dial Box Sinker.....	11, 13				
Dodgers.....	23				
Downrigger Weight Cradle.....	12				
Drain Plugs.....	43				
Drifters, Easy and Spin.....	23				
E					
Eyelets, No-Knot.....	2				
F					
Files, Hook.....	37				
Fillet Board.....	37				
First-Aid Kits.....	43				
Flags, Boat.....	43				
Flashers.....	23				
Flies.....	18, 20, 24				
Float, Batteries.....	14				
Float, Rope.....	48				
Float Weights.....	17				
Floats.....	14-17				
Floats, Crab & Shrimp.....	48-49				
Fly Boxes.....	36				
G					
Gauge, Shellfish.....	48				
Gaffs.....	30				
Gig, Frog.....	27				
Glasses, Polarized.....	32				
Gloves.....	42				
Glue Stick.....	34				
H					
Harness, Crab Trap.....	47				
Harness, Drift Sock.....	44				
Head Net, Mosquito.....	33				
Hoist, Pulley.....	42				
Hone, Sharpening.....	37				
Hook Holder.....	36				
Hook Removers.....	38				
Hooks.....	3-5, 18				
Hooks, Snelled.....	3				
I					
Ice Fishing Gear.....	40-41				
Ice Escape.....	41				
J					
Jig Eye Tool.....	21				
Jig Heads.....	21				
Jigs.....	21				
Jigs, Ice.....	40-41				
Jigs, Squid.....	23				
Jon, Portable.....	43				
K					
Key Float.....	43				
Kit, Fisherman's.....	37				
Kits, Lure & Tackle.....	19				
Knife, Bait.....	37				
Knife, Field Dressing.....	42				
Knife, Pin Bone.....	37				
Knife & Pliers Holder.....	37				
Knives, Filet.....	37				
Knives, Oyster.....	37				
L					
Lead Cinches.....	9				
Lead Wire.....	9				
Leader Pouch.....	36				
Leaders, Tapered.....	2				
Leaders, Wire.....	2				
License Holder.....	32				
Light Sticks.....	48				
Line, Crab.....	48				
Line Cutters.....	38				
Line, Furnished.....	34				
Line, Snaps.....	48				
Lines, Ice.....	40				
Lines, Monofilament.....	2				
Lip Grip & Scale.....	30				
Lure Illuminator.....	41				
Lures.....	18-25				
Lures, Ice.....	40-41				
M					
Marine Gear & Accessories.....	43-44				
Minnow Nets & Seines.....	26, 30				
Minnow Traps.....	26				
Minnow Umbrella Net.....	26				
Motor Flusher.....	43				
N					
Net, Butterfly.....	29				
Net Display Racks.....	30				
Net, Umbrella.....	26				
Nets, Bait, Dip & Scoop.....	29, 30				
Nets, Cast.....	26				
Nets, Landing.....	28, 29				
Nets, Replacement.....	30				
P					
Pliers.....	39				
Pliers & Knife Holder.....	37				
Pliers, Skinning.....	38				
Poles, Bamboo.....	34				
Poncho, Emergency.....	33				
Poppers.....	18, 20				
Practice Plugs.....	14				
R					
Reel Grease & Oil.....	42				
Reel, Retractable Accessory.....	32				
Reel / Rod Display Cradle.....	35				
Reel Seat Display Handles.....	35				
Reels, Ice.....	40				
Rigs, Freshwater.....	18				
Rigs & Leaders, Saltwater.....	24, 25				
Rod Holders.....	35				
Rod Racks.....	34, 35				
Rod Tip Tops.....	34				
Rods, Ice.....	40				
Rope, Lead Core.....	48				
S					
Sand Spikes.....	35				
Saw, Pack.....	42				
Scalers.....	38				
Scales.....	30, 31				
Scissors.....	38				
Screwdriver Set.....	37				
Seines, Minnow.....	26				
Shear, Sportsman's.....	38				
Shrimp Devainer.....	48				
Shrimp Trap.....	45				
Sinker Selectors.....	11, 13				
Sinker Slides.....	8				
Sinker Stops.....	14				
Sinkers, Lead.....	10-13, 18				
Sinkers, Steel & Tin.....	13				
Skimmers, Ice.....	41				
Sleeves, Connector.....	2				
Slinky Cord.....	9				
Slinky Shot.....	9				
Slinky Tube & Ramrod.....	9				
Slinky Weights.....	9				
Snaps.....	8				
Spears, Fish.....	27				
Spears, Frog.....	27				
Spike, Ground.....	43				
Spinners.....	19, 22				
Split Rings.....	8				
Spoons.....	19, 22				
Spreader Arm.....	18				
Spreader Bars.....	25				
Spreaders, Fish Mouth.....	38				
Spreaders, Trolling.....	23				
Squid Baits.....	24				
Squid Jigs.....	23				
Stack Pack Jars.....	36				
Steel, Sharpening.....	37				
Stringers.....	31				
Suspenders, Wader.....	32				
Swivels.....	6-8, 18				
T					
Tackle Boxes.....	36				
Threaders, Bait & Worm.....	36				
Tip-Ups, Ice.....	40				
Tong, Crab.....	48				
Tool Kit.....	37				
Tools, Multi-Function.....	39				
Trot Lines.....	34				
Tubing, Latex.....	9				
U					
Uniform Product Codes.....	50-64				
V					
Vests, Fishing.....	33				
W					
Warmers, Hand, Toe & Body.....	42				
Weight Cradle.....	12				
Weights.....	12				
Weights, Crab Line & Trap.....	48				
Whistle.....	43				
Worm Blower.....	36				
Worm Harnesses.....	18				
Worm Threader.....	36				
<p>Catalog number 68 printed and distributed in the U.S.A. for The Danielson Company, Inc. Copyright © 1987, 1988, 1989, 1990, 1991, 1992, 1994, 1996, 1998, 2000, 2002, 2005, and 2007.</p> <p>The Danielson Company, Inc. All rights reserved. Danielson®, Danco®, Danielson Marine®, BlackHawk®, Kurotaka®, EnviroQuest®, Enchantress®, Zing Tail® and WeatherGuard® are registered trademarks of The Danielson Company, Inc.</p> <p>No portion of this catalog may be reproduced or copied in any way other than that for which it is intended without the expressed written consent of The Danielson Company, Inc.</p> <p>Notice: Product size descriptions are approximate only. Product art does not accurately represent actual size. Product art may not accurately represent actual product design and function.</p>					

Line Dispenser

Keep your line from unwinding and tangling with the line dispenser. You will always have easy tangle free access to your line by simply strapping the line dispenser around your spool and pulling it through.



NO. LDP3.

Packed 3 each per polybag with fold-over header card, 12 per inner box, 288 per case. Approx. case wtg. 7 lbs.

Plus 7 Monofilament Nylon

Plus 7 monofilament nylon line is formulated for superior flexibility and limpness for accurate, effortless casting and line control. Low stretch and a high-tensile strength give this line excellent hook-setting capabilities. It's made to resist cuts, scuffs and scrapes that can weaken line.

NO. 418B (mist blue)

NO. 418C (clear)

NO. 418G (green)

Packed 1 spool shrink wrapped with label, 12 spools per inner box, 120 per case. Approx. case wtg. 25 lbs.



code	lb. test	approx. yardage
4	4 lb.	900
6	6 lb.	800
8	8 lb.	670
10	10 lb.	500
12	12 lb.	400
15	15 lb.	300
20	20 lb.	275
25	25 lb.	225
30	30 lb.	200
40	40 lb.	150
50	50 lb.	120
60	60 lb.	90
80	80 lb.	65

Knotless Tapered Leaders

These knotless, tapered leaders offer anglers a precise, uniform taper for perfect balance. Designed with a heavy butt to ensure a smooth turnover and natural presentation of the fly, they are supple enough to straighten out for effortless, accurate casting.

NO. KTL

Packed 1 coil per polybag with insert card, 12 cards per inner box, 480 per case. Approx. case wtg. 6 lbs.

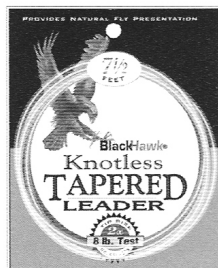

code	lgth.	lb. test	tip size	butt dia.	tip dia.
752X	7.5'	8	2X	.023"	.009"
753X	7.5'	6.5	3X	.021"	.008"
754X	7.5'	5	4X	.021"	.007"
755X	7.5'	4	5X	.021"	.006"
756X	7.5'	3	6X	.017"	.005"
757X	7.5'	2	7X	.017"	.004"
902X	9'	8	2X	.023"	.009"
903X	9'	6.5	3X	.021"	.008"
904X	9'	5	4X	.021"	.007"
905X	9'	4	5X	.021"	.006"
906X	9'	3	6X	.017"	.005"
907X	9'	2	7X	.017"	.004"

No-Knot Eyelets

Forget loops, nail knots and splices with this speedy and easy method of joining tapered leader to fly line. Simply insert the barbed pin of the eyelet into the end of the fly line and you are able to add or change leaders quickly.



NO. FLE2

Packed 3 small and 3 large per polybag on a display card, 12 cards per inner box, 2,400 per case. Approx. case wtg. 11 lbs.

Connector Sleeves

Used with monofilament or wire, these connector sleeves are great for making leaders or rigs. They are the surest way to make a non-slip loop or join two lengths of stranded wire.

NO. CSLVB (black)

NO. CSLVN (nickel)

Packed 30 per polybag with full back header card, 12 cards per inner box, 480 per case.

sleeve size	10	20	40	80	100
inside diameter	o	o	o	o	o

code	inside dia. in.	inside dia. mm	approx. case wtg.
10	.042	1.1	8 lbs.
20	.051	1.3	9 lbs.
40	.063	1.6	10 lbs.
80	.070	1.8	11 lbs.
100	.078	2.0	12 lbs.

Wire Leaders

Perfect for toothy fish and rocky environments these nylon-coated leaders are constructed with spring-tempered stainless steel wire. Preformed and stranded to the proper pitch to ensure flexibility they feature sleeve-cripped crane swivel and interlock snap.

NO. WL (clear)

NO. WLB (black)

Packed 3 per polybag with insert card, 12 cards per inner box, 600 per case.

code	lb. test	length	approx. case wtg.
206	20 lb.	6"	14 lbs.
209	20 lb.	9"	15 lbs.
2012	20 lb.	12"	14 lbs.
2018	20 lb.	18"	15 lbs.
306	30 lb.	6"	15 lbs.
309	30 lb.	9"	16 lbs.
3012	30 lb.	12"	15 lbs.
3018	30 lb.	18"	16 lbs.
3024	30 lb.	24"	18 lbs.
4512	45 lb.	12"	16 lbs.
4518	45 lb.	18"	17 lbs.



Wire Leaders with Ball Bearing Swivels

Featuring a ball bearing swivel for maximum protection against twists, tangles and kinks these nylon-coated leaders are constructed with preformed, spring-tempered stainless steel wire stranded to the proper pitch to ensure flexibility. Swivel and interlock snap are sleeve-cripped.

NO. WLBB

Packed 3 per polybag with insert card, 12 cards per inner box, 600 per case.

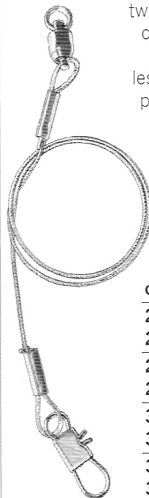

code	lb. test	length	approx. case wtg.
206	20 lb.	6"	14 lbs.
209	20 lb.	9"	15 lbs.
2012	20 lb.	12"	16 lbs.
2018	20 lb.	18"	17 lbs.
306	30 lb.	6"	15 lbs.
309	30 lb.	9"	16 lbs.
3012	30 lb.	12"	15 lbs.
3018	30 lb.	18"	16 lbs.
3024	30 lb.	24"	18 lbs.

Wire Leader Material

This wire leader material is extremely flexible and resists kinking. Made tough with a spring-tempered, multi-strand stainless steel wire, it features a clear nylon coating that adds protection and reduces fraying. (Packaged on a dispenser spool).

NO. LDRWC

Packed 30 ft. wound on a plastic spool with peg-boardable tab and insert label, 12 spools per inner box, 600 per case.

code	lb. test	approx. dia. in.	approx. dia. mm	approx. case wtg.
15	15 lb.	0.019	0.48	32 lbs.
20	20 lb.	0.020	0.51	33 lbs.
30	30 lb.	0.022	0.56	35 lbs.
45	45 lb.	0.025	0.63	37 lbs.
60	60 lb.	0.029	0.73	39 lbs.



Ultra Thin Wire Leaders

Designed for use with action-sensitive lures these ultra-thin, super-tough, flexible wire leaders eliminate bite-offs. Hand-wrapped and assembled with a crane swivel the 12-lb and 18-lb leaders are fitted with strong dual lock snaps, the 27-lb, 36-lb and 55-lb come with a rugged coast lock snap. Available in sizes and strengths for most any toothy fish situation.

NO. WLUT

Packed 3 per blister card, 12 cards per inner box, 600 per case.

code	lb. test	length	approx. case wtg.
125	12 lb.	5"	16 lbs.
128	12 lb.	8"	16 lbs.
185	18 lb.	5"	16 lbs.
188	18 lb.	8"	16 lbs.
275	27 lb.	5"	16 lbs.
278	27 lb.	8"	16 lbs.
2712	27 lb.	12"	17 lbs.
368	36 lb.	8"	17 lbs.
3612	36 lb.	12"	17 lbs.
558	55 lb.	8"	18 lbs.
5512	55 lb.	12"	18 lbs.



Wire-Wound Wire Leaders

Wire-wound at the ends for more strength, less visibility and greater weed resistance than sleeve-cripped versions, these multi-strand, nylon-coated leaders are perfect for toothy fish and rocky environments. Assembled with a crane swivel and a dual lock snap.

NO. WLW

Packed 3 per polybag with insert card, 12 cards per inner box, 600 per case.



code	lb. test	length	approx. case wtg.
206	20 lb.	6"	12 lbs.
209	20 lb.	9"	12 lbs.
2012	20 lb.	12"	14 lbs.
306	30 lb.	6"	13 lbs.
309	30 lb.	9"	14 lbs.
3012	30 lb.	12"	14 lbs.
3018	30 lb.	18"	15 lbs.
3024	30 lb.	24"	16 lbs.
4512	45 lb.	12"	15 lbs.
4518	45 lb.	18"	16 lbs.

Wire Leader Assortment

Perfect for fresh or saltwater, this assortment has six 6" and four 9" wire leaders. They are made tough with a spring-tempered, multi-strand stainless steel wire and are coated in nylon for added protection and to eliminate fraying.

NO. 4835

Packed 1 assortment per polybag with insert card, 12 cards per inner box, 240 per case. Approx. case wtg. 12 lbs.



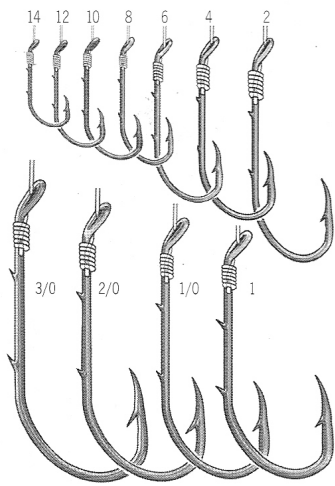

Snelled Baitholder Hooks

A favorite of fishermen, these forged, down-eye, offset baitholder hooks have a bronze finish and needle sharp points. Double sliced barbs on the back of the shank keep bait in place. Snelled on 7" leaders.

NO. 30 (bronze)
Packed 6 hooks per pack, 24 packs per inner box.

code	size	packs/ case	approx. case wgt.
14	14	2,400	30 lbs.
12	12	2,400	30 lbs.
10	10	2,400	31 lbs.
8	8	2,400	33 lbs.
6	6	2,400	35 lbs.
4	4	2,400	37 lbs.
2	2	1,200	21 lbs.
1	1	1,200	23 lbs.
1/0	1/0	1,200	24 lbs.
2/0	2/0	1,200	25 lbs.
3/0	3/0	1,200	29 lbs.

Snelled Salmon Egg Hooks

These electronically gold-plated egg hooks are snelled on 7" leaders and have a sliced shank to hold bait firmly in place. Hooks have forged, extra short shanks, turned-up eyes and razor sharp points for great hook-setting.

NO. 36 (gold)
Packed 6 hooks per pack, 24 packs per inner box.

code	size	packs/ case	approx. case wgt.
14	14	2,400	28 lbs.
12	12	2,400	28 lbs.
10	10	2,400	28 lbs.
8	8	2,400	29 lbs.

Snelled Treble Hooks

Perfect for today's dough baits, these electronically gold-plated treble hooks are snelled with an 18" leader. Tempered for strength, they feature finely honed curved points.

NO. HTTG (gold)
Packed 3 hooks per pack, 24 packs per inner box.

code	size	packs/ case	approx. case wgt.
18	18	1,152	16 lbs.
16	16	1,152	17 lbs.
14	14	1,152	17 lbs.

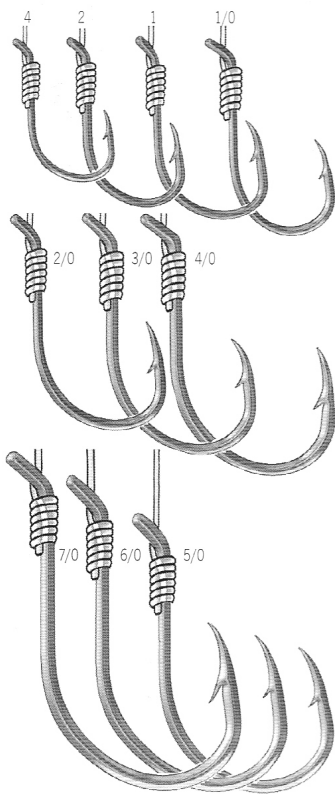

Snelled Octopus Hooks

The extra sharp points and turned-up eyes of these hooks guarantee solid hook-ups. These forged, extra strong offset hooks are snelled on 7" leaders.

NO. 128NOH (nickel)
Packed 6 hooks per pack, 24 packs per inner box.

code	size	packs/ case	approx. case wgt.
4	4	1,200	19 lbs.
2	2	1,200	20 lbs.
1	1	1,200	22 lbs.
1/0	1/0	1,200	23 lbs.
2/0	2/0	1,200	26 lbs.
3/0	3/0	1,200	30 lbs.
4/0	4/0	600	20 lbs.
5/0	5/0	600	21 lbs.
6/0	6/0	600	24 lbs.
7/0	7/0	600	27 lbs.

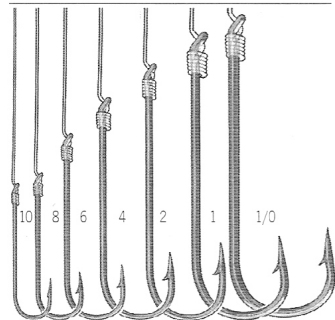

Snelled Aberdeen Hooks

Perfect for fishing in brushy waters, these electronically gold-plated hooks are tempered to bend before breaking. Snelled on 7" leaders, these light wire, long shank hooks are great with minnows.

NO. 126AG (gold)
Packed 6 hooks per pack, 24 packs per inner box.

code	size	packs/ case	approx. case wgt.
10	10	2,400	29 lbs.
8	8	2,400	30 lbs.
6	6	2,400	33 lbs.
4	4	2,400	35 lbs.
2	2	1,200	19 lbs.
1	1	1,200	21 lbs.
1/0	1/0	1,200	22 lbs.

Snelled Baitholder Hook Assortment

These snelled, extra sharp, forged down-eye, offset hooks store in a reusable fold-over card. This popular 60-piece assortment contains 15 double sliced, bronze baitholder hooks in each of sizes 8, 6, 4 and 2.

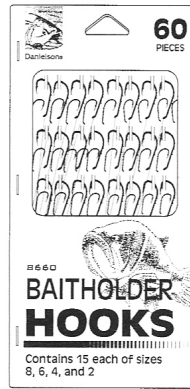

NO. 8660
Packed 60 hooks per pack, 12 packs per inner box, 240 per case. Approx. case wgt. 27 lbs.

Snelled Aberdeen Hook Assortment

This 40-piece assortment includes eight snelled, gold Aberdeen hooks in each of sizes 10, 8, 6, 4 and 2. These long-shank, light wire hooks are tempered to bend before breaking. Conveniently stored in a reusable, fold-over card.

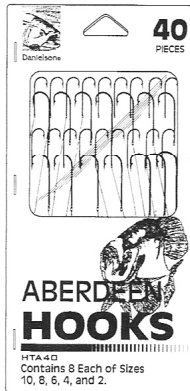

NO. HTA40
Packed 40 hooks per pack, 12 packs per inner box, 240 per case. Approx. case wgt. 22 lbs.

Snelled Trout Hook Assortment

The smorgasbord of snelled hooks in this assortment has been specifically selected for trout fishing. This 36-piece set contains 18 snelled bronze baitholder hooks and 18 snelled gold salmon egg hooks, each style in 3 sizes 8, 10 and 12. Packaged in a reusable fold-over card.

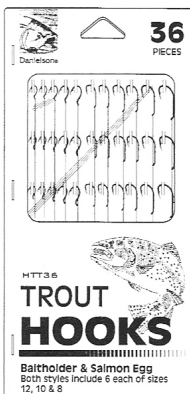

NO. HTT36
Packed 36 hooks per pack, 12 packs per inner box, 240 per case. Approx. case wgt. 20 lbs.

Trout Hook Assortment

This 60-piece set has all the sizes and styles of hooks that trout fishing demands. This assortment includes a variety of baitholder, live bait and gold treble hooks.

NO. HAT
Packed 60 hooks per clam-pack with header card, 12 packs per inner box, 120 per case. Approx. case wgt. 10 lbs.

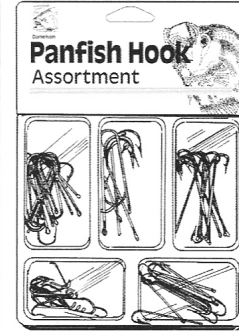

Bass Hook Assortment

This 45-piece hook assortment has all the sizes and styles required for incredible bass fishing. The set includes baitholder, worm and weedless sproat hooks.

NO. HAB
Packed 45 hooks per clam-pack with header card, 12 packs per inner box, 120 per case. Approx. case wgt. 14 lbs.

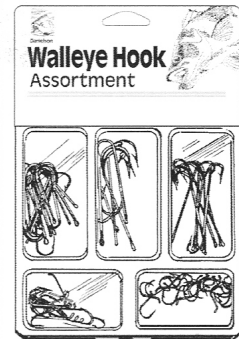

Walleye Hook Assortment

This assortment has everything you need for great walleye fishing. The 60-piece hook set includes a variety of Aberdeen, baitholder and live bait hooks.

NO. HAW
Packed 60 hooks per clam-pack with header card, 12 packs per inner box, 120 per case. Approx. case wgt. 11 lbs.

Catfish Hook Assortment

This 40-piece set has all the styles and sizes of hooks required for great catfishing. The assortment includes bronze baitholder and dough bait treble hooks.

NO. HAC
Packed 40 hooks per clam-pack with header card, 12 packs per inner box, 120 per case. Approx. case wgt. 13 lbs.

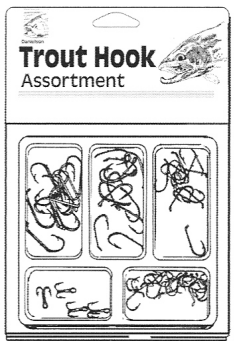

Panfish Hook Assortment

This versatile set contains 60 assorted sizes and styles of hooks for all kinds of panfishing. The assortment includes Aberdeen, Carlisle and baitholder hooks.

NO. HAP
Packed 60 hooks per clam-pack with header card, 12 packs per inner box, 120 per case. Approx. case wgt. 10 lbs.

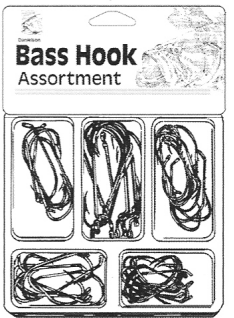

Bait Hook Assortment Tin

This assortment has a hook style and size for just about any type of bait fishing. The 40-piece set contains a variety of Limerick, Kirby and Carlisle hooks.

NO. 4832
Packed 40 hooks per tin on a blister card, 12 cards per inner box, 144 per case. Approx. case wgt. 12 lbs.

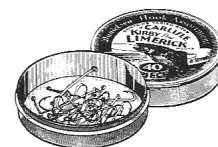
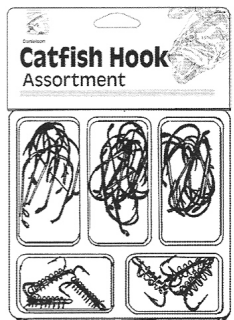

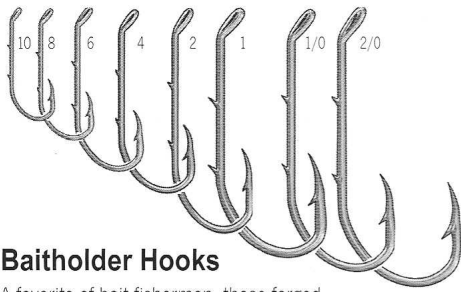

Baitholder Hooks

A favorite of bait fishermen, these forged, down-eye, offset baitholder hooks have a bronze finish and needle sharp points. Double sliced barbs on the back of the shank keep bait where it belongs.

code	size	pcs./card	approx. case wgt.
NO. HXBBR (bronze)			
10	10	10	7 lbs.
8	8	10	7 lbs.
6	6	10	8 lbs.
4	4	10	9 lbs.
2	2	9	10 lbs.
1	1	8	11 lbs.
1/0	1/0	7	11 lbs.
2/0	2/0	7	12 lbs.

50-Pack

NO. HXBBR50 (bronze)
Packed 50 hooks in a polybag on a display card, 12 cards per inner box, 240 per case.

code	size	approx. case wgt.
8	8	8 lbs.
6	6	9 lbs.
4	4	11 lbs.
2	2	14 lbs.
1	1	16 lbs.

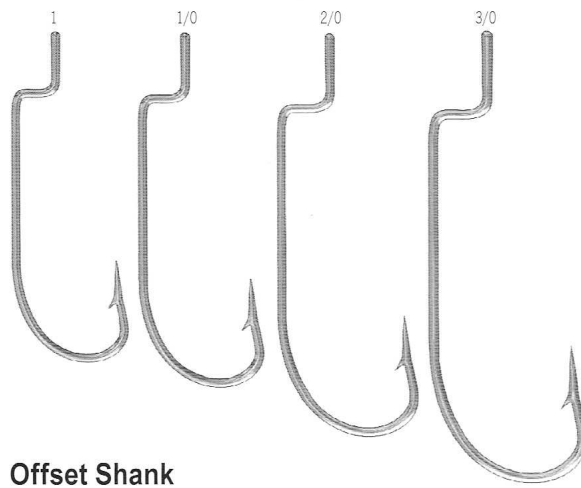

Offset Shank Worm Hooks

Designed for plastic worm rigs, these sproat-style hooks feature a blue finish and kinked shanks for better hook-set.

NO. HXWBL

(blue)
Packed by varied piece count per size in a polybag on a display card, 12 cards per inner box, 600 per case.

code	size	pcs./card	approx. case wgt.
1	1	12	15 lbs.
1/0	1/0	10	16 lbs.
2/0	2/0	9	17 lbs.
3/0	3/0	8	24 lbs.

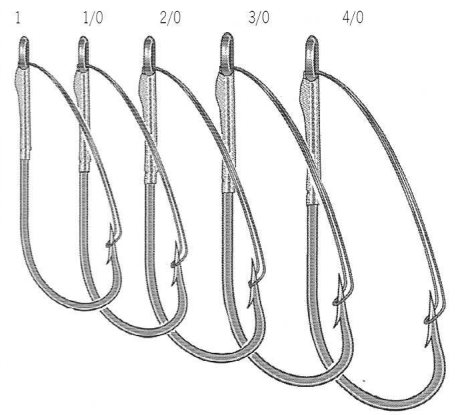

Weedless Sproat Hooks

A permanent bonded weed guard makes these long shank, bronze sproat hooks perfect for fishing in water with stumps, lily pads, moss and other debris that commonly snag ordinary style hooks.

code	size	pcs./card	approx. case wgt.
NO. HXWSBR (bronze)			
1	1	4	9 lbs.
1/0	1/0	4	10 lbs.
2/0	2/0	3	10 lbs.
3/0	3/0	3	11 lbs.
4/0	4/0	2	10 lbs.

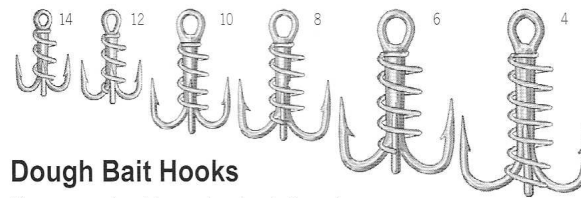

Dough Bait Hooks

These curved-point, regular shank, forged bronze treble hooks are fitted with a brass spring for holding all kinds of bait.

NO. 562SP

(bronze)
Packed by varied piece count per size in a polybag on a display card, 12 cards per inner box, 600 per case.

code	size	pcs./card	approx. case wgt.
14	14	3	7 lbs.
12	12	3	7 lbs.
10	10	3	8 lbs.
8	8	2	8 lbs.
6	6	2	9 lbs.
4	4	2	10 lbs.

25-Pack

NO. 562MB (bronze)
Packed 25 hooks per blister card, 12 cards per inner box, 600 per case.

code	size	approx. case wgt.
14	14	16 lbs.
12	12	17 lbs.
10	10	23 lbs.
8	8	27 lbs.

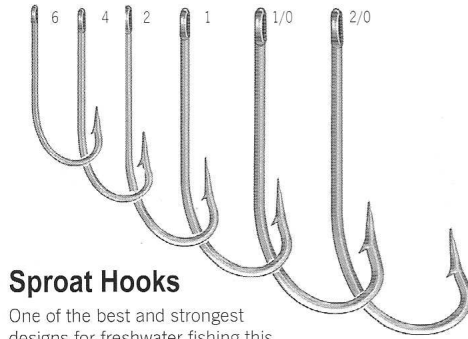

Sproat Hooks

One of the best and strongest designs for freshwater fishing this sproat hook features a parabolic bend, straight point and ringed eye. Ideal for use with plastic baits.

NO. HXSN

(nickel)
NO. HXSNB (blk/nkl)
Packed by varied piece count per size in a polybag on a display card, 12 cards per inner box, 600 per case.

code	size	pcs./card	approx. case wgt.
6	6	10	8 lbs.
4	4	10	8 lbs.
2	2	9	9 lbs.
1	1	8	8 lbs.
1/0	1/0	6	7 lbs.
2/0	2/0	5	7 lbs.

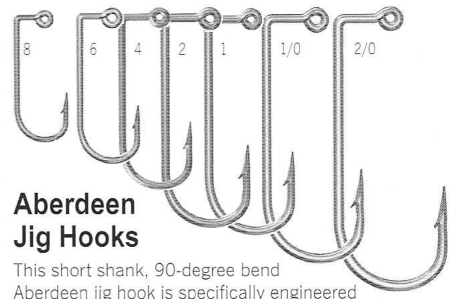

Aberdeen Jig Hooks

This short shank, 90-degree bend Aberdeen jig hook is specifically engineered for lead head jigs and other molded applications. Made with light wire and tempered to flex before breaking, it is ideal for fishing in brushy water.

code	size	pcs./card	approx. case wgt.
NO. HXAJB (bronze)			
8	8	8	7 lbs.
6	6	8	8 lbs.
NO. HXAJG (gold)			
4	4	8	9 lbs.
2	2	8	10 lbs.
1	1	8	11 lbs.
1/0	1/0	7	10 lbs.
2/0	2/0	6	10 lbs.

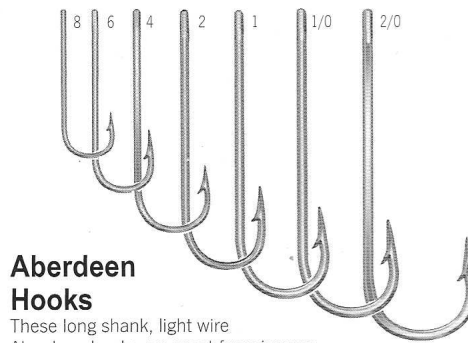

Aberdeen Hooks

These long shank, light wire Aberdeen hooks are great for minnows. And they're perfect for fishing in brushy water because they are tempered to bend before breaking.

NO. HXAB

(bronze)
NO. HXAG (gold)
Packed by varied piece count per size in a polybag on a display card, 12 cards per inner box, 600 per case.

code	size	pcs./card	approx. case wgt.
8	8	12	7 lbs.
6	6	12	8 lbs.
4	4	12	9 lbs.
2	2	12	10 lbs.
1	1	10	10 lbs.
1/0	1/0	8	10 lbs.
2/0	2/0	7	10 lbs.

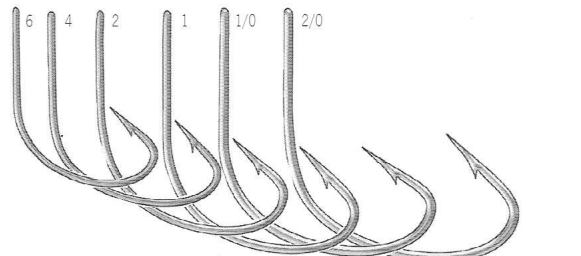

Wide Gap Hooks

The wide gap engineering places the hook deeper inside the fish's mouth for a solid hook set and prevention of lip tear out. Straight eye design is ideal for use with bait fish.

NO. HXWGB

(bronze)
Packed by varied piece count per size in a polybag on a display card, 12 cards per inner box, 600 per case.

code	size	pcs./card	approx. case wgt.
6	6	10	8 lbs.
4	4	10	9 lbs.
2	2	9	9 lbs.
1	1	8	9 lbs.
1/0	1/0	7	8 lbs.
2/0	2/0	6	8 lbs.

Weighted Treble Hooks

The weight of this treble hook is cast around the shaft of the hook to provide good casting characteristics and holds your line in the water. Where legal, this hook is used to catch fish by snagging and can also be helpful in retrieving objects from the bottom.

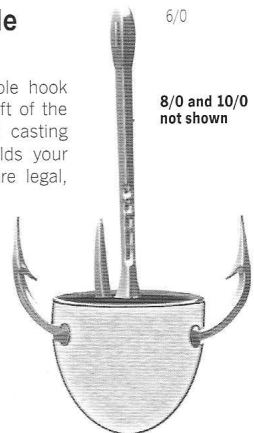

NO. HXBSHB

Bulk packed by varied piece count.

code	size	pcs./bag	pcs./case	approx. case wgt.
6/0	6/0	20	320	27 lbs.
8/0	8/0	20	240	27 lbs.
10/0	10/0	10	150	26 lbs.

Bronze Treble Hooks

These curved point, regular shank, forged bronze treble hooks are tempered and brazed for strength. Featuring razor sharp, hollow ground points.

NO. 572SP (bronze)	code	size	pcs./card	approx. case wgt.
Packed by varied piece count per size in a polybag on a display card, 12 cards per inner box, 600 per case.	14	14	4	7 lbs.
	12	12	4	7 lbs.
	10	10	4	8 lbs.
	8	8	3	8 lbs.
	6	6	3	9 lbs.

Gold Treble Hooks

These superb quality treble hooks are electronically gold-plated to ensure a lasting finish.

NO. 582SP (gold)	code	size	approx. case wgt.
Packed 4 hooks per polybag on a display card, 12 cards per inner box, 600 per case.	18	18	7 lbs.
	16	16	7 lbs.
	14	14	8 lbs.
	12	12	8 lbs.

25-Pack

NO. 582MB (gold)	code	size	approx. case wgt.
Packed 25 hooks per blister card, 12 cards per inner box, 600 per case.	18	18	12 lbs.
	16	16	13 lbs.
	14	14	14 lbs.

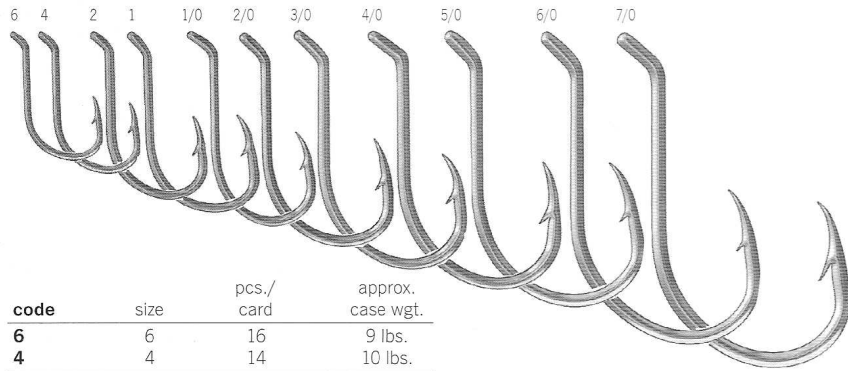

code	size	pcs./card	approx. case wgt.
6	6	16	9 lbs.
4	4	14	10 lbs.
2	2	14	11 lbs.
1	1	12	12 lbs.
1/0	1/0	12	13 lbs.
2/0	2/0	10	14 lbs.
3/0	3/0	9	16 lbs.
4/0	4/0	8	18 lbs.
5/0	5/0	7	20 lbs.
6/0	6/0	6	22 lbs.
7/0	7/0	5	23 lbs.

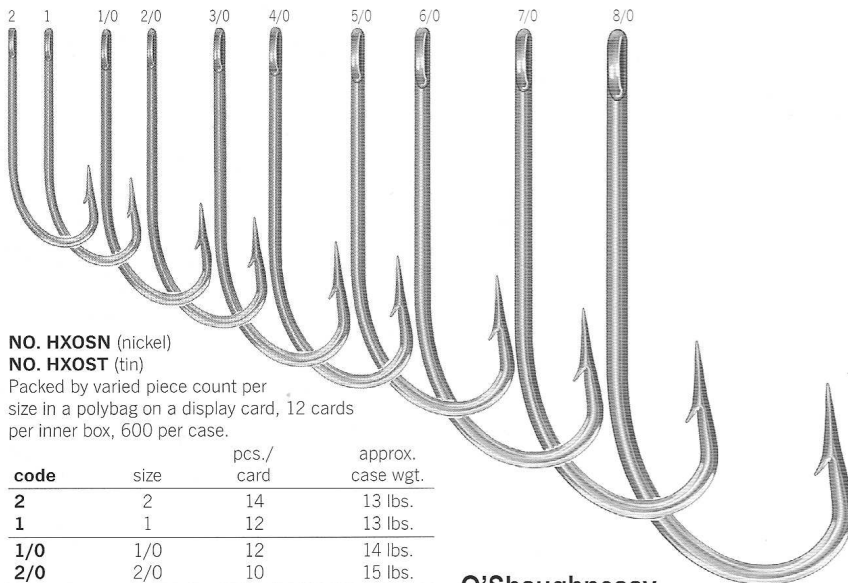

NO. HXOSN (nickel)

NO. HXOST (tin)

Packed by varied piece count per size in a polybag on a display card, 12 cards per inner box, 600 per case.

code	size	pcs./card	approx. case wgt.
2	2	14	13 lbs.
1	1	12	13 lbs.
1/0	1/0	12	14 lbs.
2/0	2/0	10	15 lbs.
3/0	3/0	10	18 lbs.
4/0	4/0	8	18 lbs.
5/0	5/0	6	17 lbs.
6/0	6/0	5	19 lbs.
7/0	7/0	4	24 lbs.
8/0	8/0	3	24 lbs.

Bronze Treble Hooks

144-Pack

NO. 572GR (bronze)

Packed 144 hooks per box, varied number of boxes per case.

code	size	boxes/case	approx. case wgt.
14	14	100	7 lbs.
12	12	100	8 lbs.
10	10	100	12 lbs.
8	8	100	18 lbs.
6	6	100	23 lbs.
4	4	100	29 lbs.
2	2	40	18 lbs.
1	1	40	21 lbs.
1/0	1/0	40	29 lbs.
2/0	2/0	20	18 lbs.
3/0	3/0	20	20 lbs.
4/0	4/0	20	27 lbs.
5/0	5/0	20	33 lbs.
6/0	6/0	20	40 lbs.
7/0	7/0	20	48 lbs.
8/0	8/0	20	60 lbs.
9/0	9/0	10	39 lbs.
10/0	10/0	10	46 lbs.

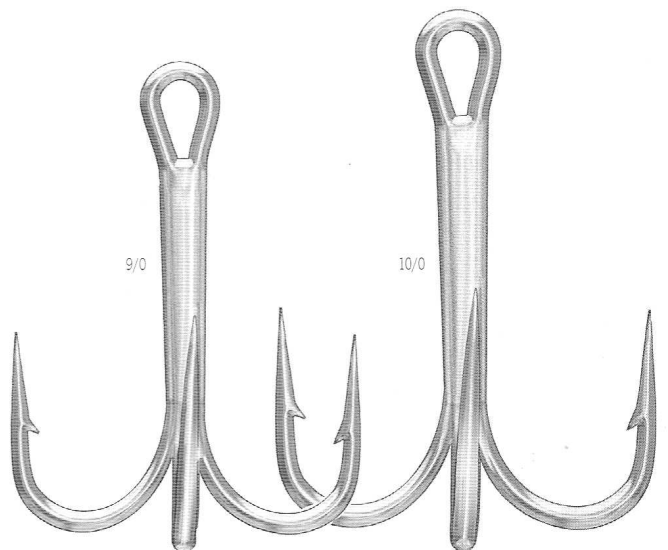
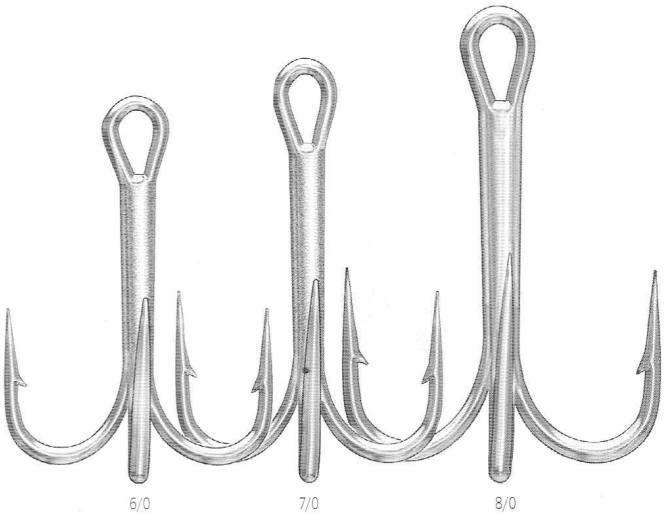
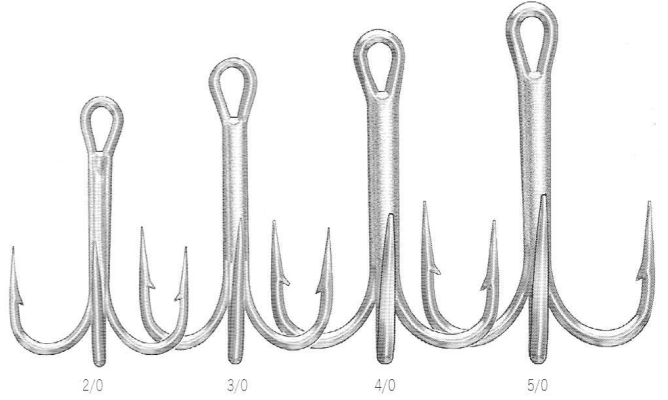
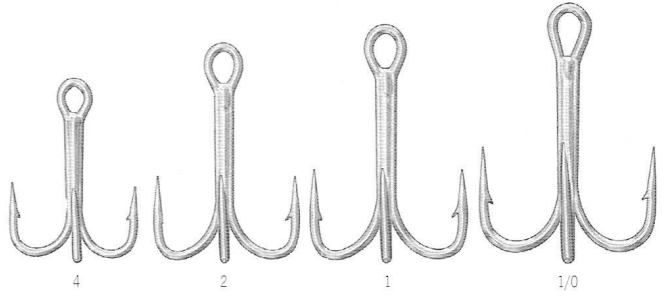
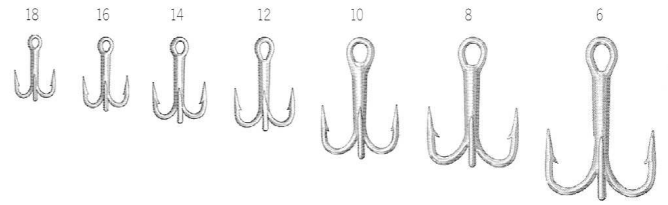

Octopus Hooks

Long, super sharp points and turned-up eyes allow for better hook-sets with these forged, extra strong, offset, nickel Octopus hooks.

NO. HXON (nickel)

Packed by varied piece count per size in a polybag on a display card, 12 cards per inner box, 600 per case.

O'Shaughnessy Hooks

Ideal for any heavy-mouthed fish! Made extra strong with heavy gauge wire, they feature ringed eyes. These hooks are great for ocean bait fishing or staged on a trot line.

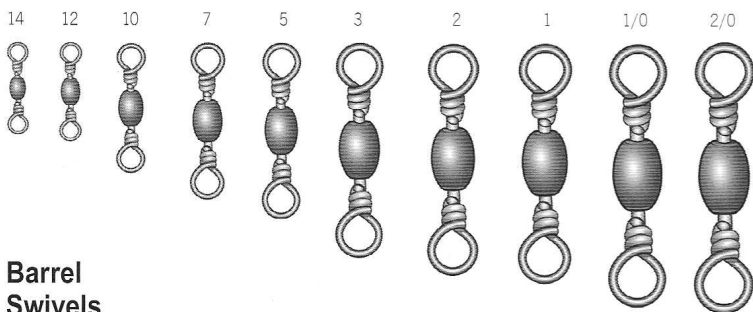

Barrel Swivels

Offering excellent no-twist protection these solid brass swivels feature twisted wire eyes.

NO. 1600SP (brass) NO. 1600SPBLK (black)

Packed by varied piece count per size in a polybag on a color coded display card, 12 cards per inner box.

code	size	pcs./card	cards/case	approx. case wgt.
14	14	8	1,200	12 lbs.
12	12	8	1,200	13 lbs.
10	10	8	1,200	16 lbs.
7	7	7	1,200	19 lbs.
5	5	6	1,200	23 lbs.
3	3	5	600	13 lbs.
2*	2	4	600	14 lbs.
1	1	4	600	15 lbs.
1/0	1/0	3	600	14 lbs.
2/0	2/0	3	600	16 lbs.

*Available in brass finish only.

12-Pack

NO. 1600GR (brass) NO. 1600GRBLK (black)

Packed 12 pieces per size in a polybag on a color coded display card, 12 cards per inner box.

code	size	cards/case	approx. case wgt.
14	14	1,200	14 lbs.
12	12	1,200	16 lbs.
10	10	1,200	20 lbs.
7	7	1,200	28 lbs.
5	5	600	18 lbs.
3	3	600	23 lbs.
1	1	300	18 lbs.
1/0	1/0	300	20 lbs.
2/0	2/0	300	24 lbs.

25-Pack

NO. 1600MB (brass) NO. 1600MBBLK (black)

Packed 25 pieces per size in a polybag on a color coded display card, 12 cards per inner box.

code	size	cards/case	approx. case wgt.
12	12	600	11 lbs.
10	10	600	16 lbs.
7	7	600	23 lbs.
5	5	600	31 lbs.

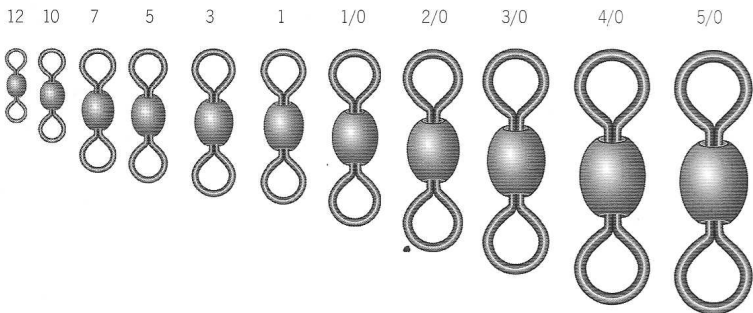

Crane Swivels

These crane swivels are designed to allow free-spinning performance that closely equals that of ball bearing swivels, but at a much lower price.

code	size	pcs./card	cards/case	approx. case wgt.
12	12	8	1,200	16 lbs.
10	10	8	1,200	17 lbs.
7	7	8	1,200	18 lbs.
5	5	6	1,200	19 lbs.
3	3	5	600	12 lbs.
1	1	4	600	12 lbs.
1/0	1/0	3	600	12 lbs.
2/0*	2/0	3	300	8 lbs.
3/0*	3/0	2	300	7 lbs.
4/0*	4/0	2	300	8 lbs.
5/0*	5/0	2	300	9 lbs.

*Available in nickel finish only.

NO. 2200SPNK (nickel) NO. 2200SPBLK (black)

Packed by varied piece count per size in a polybag on a color coded display card, 12 cards per inner box.

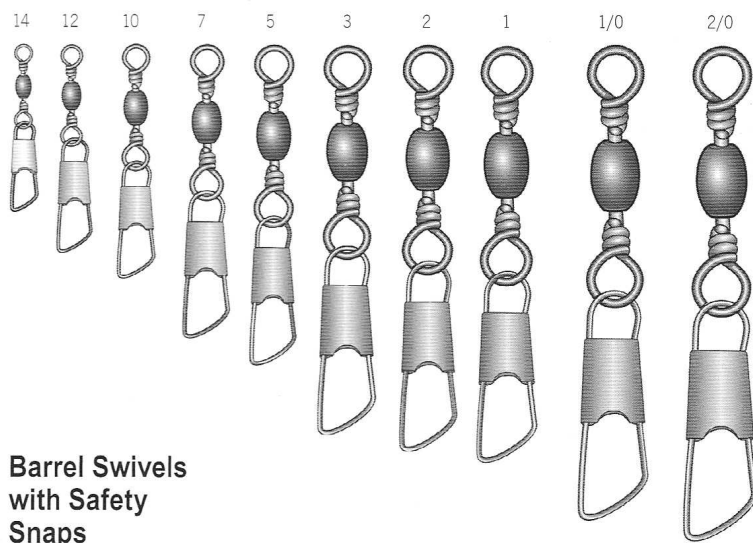

Barrel Swivels with Safety Snaps

For a quick change of a lure and leader, these solid brass swivels have an attached sure-lock safety snap.

code	size	pcs./card	cards/case	approx. case wgt.
14	14	7	1,200	14 lbs.
12	12	7	1,200	15 lbs.
10	10	7	1,200	18 lbs.
7	7	6	1,200	23 lbs.
5	5	5	1,200	24 lbs.
3	3	4	600	15 lbs.
2*	2	4	600	17 lbs.
1	1	3	600	16 lbs.
1/0	1/0	2	600	14 lbs.
2/0	2/0	2	600	15 lbs.

*Available in brass finish only.

NO. 1700SP (brass) NO. 1700SPBLK (black)

Packed by varied piece count per size in a polybag on a color coded display card, 12 cards per inner box.

code	size	cards/case	approx. case wgt.
14	14	1,200	17 lbs.
12	12	1,200	18 lbs.
10	10	1,200	24 lbs.
7	7	1,200	35 lbs.
5	5	600	22 lbs.
3	3	600	32 lbs.
1	1	300	24 lbs.
1/0	1/0	300	28 lbs.
2/0	2/0	300	33 lbs.

12-Pack

NO. 1700GR (brass) NO. 1700GRBLK (black)

Packed 12 pieces per size in a polybag on a color coded display card, 12 cards per inner box.

25-Pack

NO. 1700MB (brass) NO. 1700MBBLK (black)

Packed 25 pieces per size in a polybag on a color coded display card, 12 cards per inner box.

code	size	cards/case	approx. case wgt.
14	14	600	13 lbs.
12	12	600	15 lbs.
10	10	600	21 lbs.
7	7	600	32 lbs.

Ball Bearing Swivels with Welded Rings

These ball bearing swivels with welded rings help prevent twisted and tangled lines. They feature highly polished, stainless steel ball bearings for continuous, smooth operation and super strong, welded brass rings for all types of heavy-duty fishing.

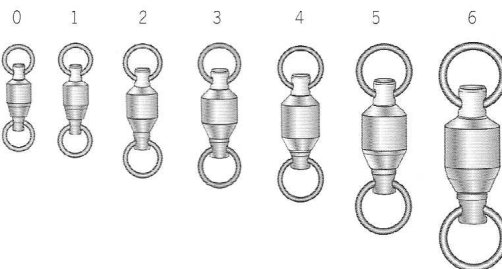

code	size	pcs./card	cards/case	approx. case wgt.
0	0	3	1,200	12 lbs.
1	1	3	1,200	13 lbs.
2	2	3	1,200	16 lbs.
3	3	3	1,200	18 lbs.
4	4	2	600	10 lbs.
5	5	2	600	11 lbs.
6	6	2	600	14 lbs.

NO. 2600SP (nickel)

Packed by varied piece count per size in a polybag on a color coded display card, 12 cards per inner box.

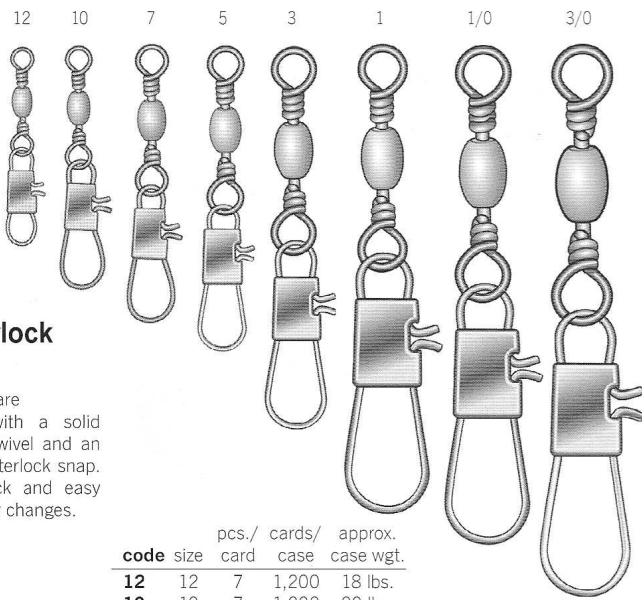

Barrel Swivels with Interlock Snaps

These swivels are constructed with a solid brass barrel swivel and an extra strong interlock snap. Great for quick and easy lure and leader changes.

code	size	pcs./ card	cards/ case	approx. case wgt.
12	12	7	1,200	18 lbs.
10	10	7	1,200	20 lbs.
7	7	6	1,200	24 lbs.
5	5	5	600	13 lbs.
3	3	4	600	15 lbs.
1	1	3	600	16 lbs.
1/0	1/0	3	600	18 lbs.
3/0	3/0	2	600	19 lbs.

NO. 2500SPNK (nickel)
NO. 2500SPBLK (black)
 Packed by varied piece count per size in a polybag on a color coded display card, 12 cards per inner box.

Ball Bearing Swivels with Interlock Snaps

These ball bearing swivels are designed to be continuously smooth and to revolve freely. They feature soldered split-rings and extra strong interlock snaps for speedy lure and leader changes.

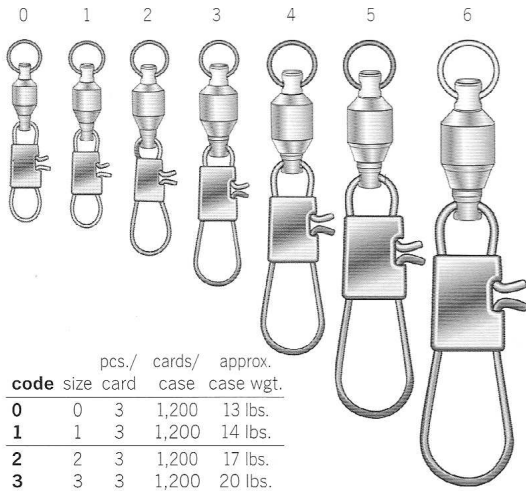

code	size	pcs./ card	cards/ case	approx. case wgt.
0	0	3	1,200	13 lbs.
1	1	3	1,200	14 lbs.
2	2	3	1,200	17 lbs.
3	3	3	1,200	20 lbs.
4	4	2	600	11 lbs.
5	5	2	600	13 lbs.
6	6	2	600	16 lbs.

NO. 2300SP (nickel)
NO. 2300SPBLK (black)
 Packed by varied piece count per size in a polybag on a color coded display card, 12 cards per inner box.

Ball Bearing Swivels with Coastlock Snaps

Smooth ball bearing swivel provides protection against twisted and tangled line and strong, stainless steel coastlock snap stands up to the toughest fishing conditions.

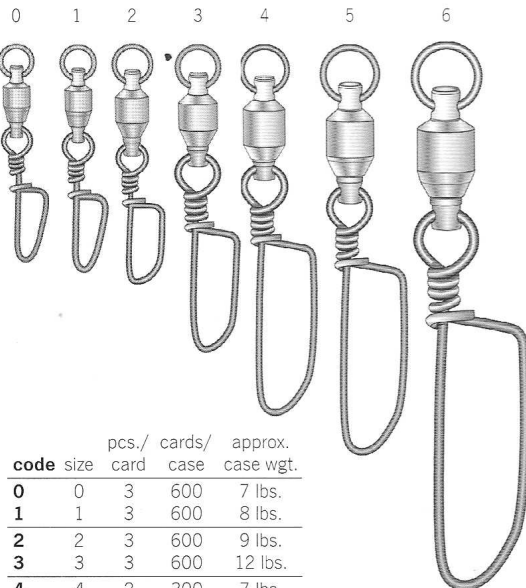

code	size	pcs./ card	cards/ case	approx. case wgt.
0	0	3	600	7 lbs.
1	1	3	600	8 lbs.
2	2	3	600	9 lbs.
3	3	3	600	12 lbs.
4	4	2	300	7 lbs.
5	5	2	300	8 lbs.
6	6	2	300	10 lbs.

NO. 2700SPBLK (black)
 Packed by varied piece count per size in a polybag on a color coded display card, 12 cards per inner box.

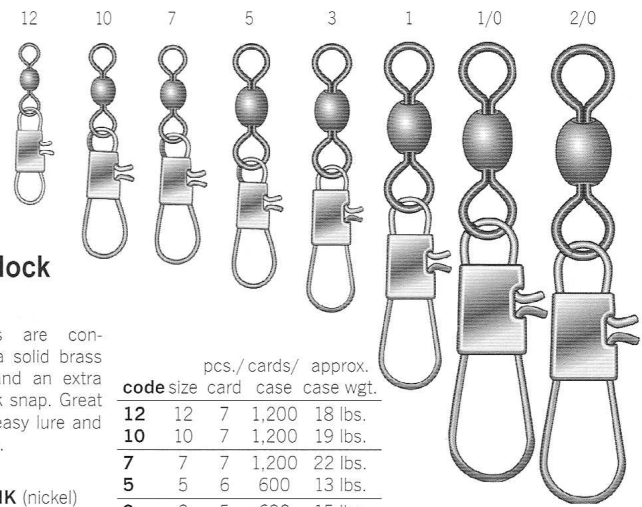

Crane Swivels with Interlock Snaps

These swivels are constructed with a solid brass crane swivel and an extra strong interlock snap. Great for quick and easy lure and leader changes.

code	size	pcs./ card	cards/ case	approx. case wgt.
12	12	7	1,200	18 lbs.
10	10	7	1,200	19 lbs.
7	7	7	1,200	22 lbs.
5	5	6	600	13 lbs.
3	3	5	600	15 lbs.
1	1	4	600	15 lbs.
1/0	1/0	3	600	16 lbs.
2/0	2/0	2	600	14 lbs.

NO. 2100SPNK (nickel)
 Packed by varied piece count per size in a polybag on a color coded display card, 12 cards per inner box.

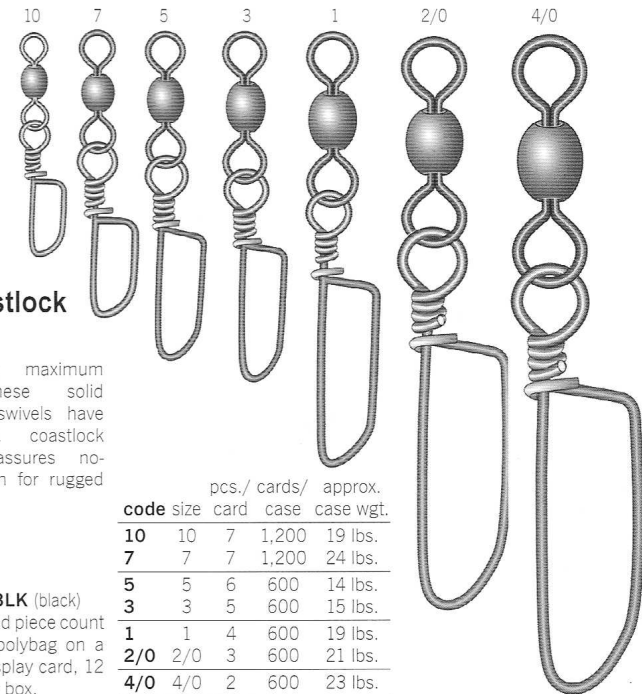

Crane Swivels with Coastlock Snaps

Designed for maximum strength, these solid brass crane swivels have an attached, coastlock snap that assures no-twist protection for rugged fishing.

code	size	pcs./ card	cards/ case	approx. case wgt.
10	10	7	1,200	19 lbs.
7	7	7	1,200	24 lbs.
5	5	6	600	14 lbs.
3	3	5	600	15 lbs.
1	1	4	600	19 lbs.
2/0	2/0	3	600	21 lbs.
4/0	4/0	2	600	23 lbs.

NO. 2400SPBLK (black)
 Packed by varied piece count per size in a polybag on a color coded display card, 12 cards per inner box.

Corkscrew Swivels

The corkscrew bucktail fastener is designed for quick and easy leader and rig changes without tying. Assembled with a crane swivel for maximum protection against twisted and tangled lines, this swivel is a must for big game fishing.

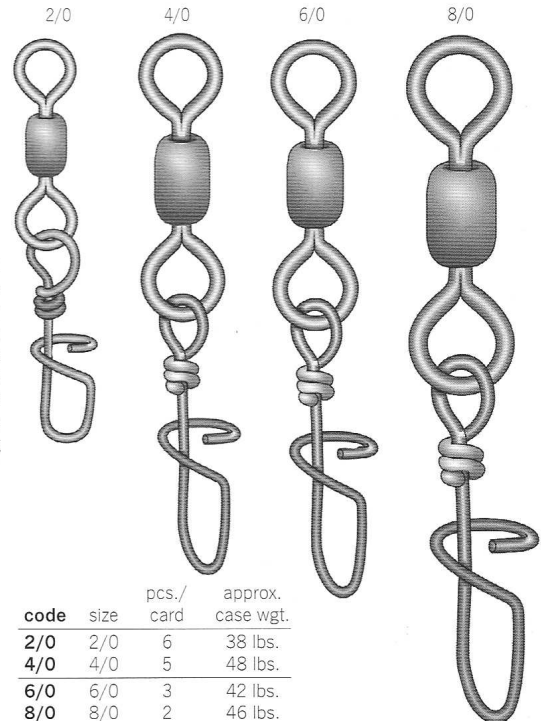

NO. CBSBLK (black)
 Packed by varied piece count per size in a polybag with insert card, 12 cards per inner box, 600 per case.

code	size	pcs./ card	approx. case wgt.
2/0	2/0	6	38 lbs.
4/0	4/0	5	48 lbs.
6/0	6/0	3	42 lbs.
8/0	8/0	2	46 lbs.

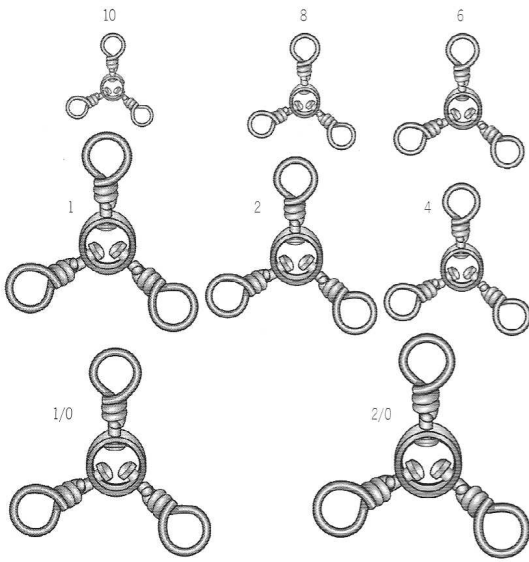

3-Way Swivels

Ideal for using with a sinker drop or fishing dual lines. Constructed with a solid brass collar and three twisted wire eyes.

NO. 1800SP (brass)
NO. 1800SPLK (black)
 Packed by varied piece count per size in a polybag on a color coded display card, 12 cards per inner box.

12-Pack
NO. 1800GR (brass)
 Packed 12 pieces per polybag on a color coded display card, 12 cards per inner box.

code	size	pcs./card	cards/case	approx. case wgt.
10	10	8	1,200	14 lbs.
8	8	8	1,200	12 lbs.
6	6	6	1,200	18 lbs.
4	4	4	600	9 lbs.
2	2	3	600	10 lbs.
1	1	3	600	13 lbs.
1/0	1/0	2	600	12 lbs.
2/0	2/0	2	600	13 lbs.

code	size	cards/case	approx. case wgt.
8	8	600	9 lbs.
6	6	600	15 lbs.
4	4	600	19 lbs.
2	2	300	19 lbs.
1	1	300	20 lbs.
1/0	1/0	300	25 lbs.

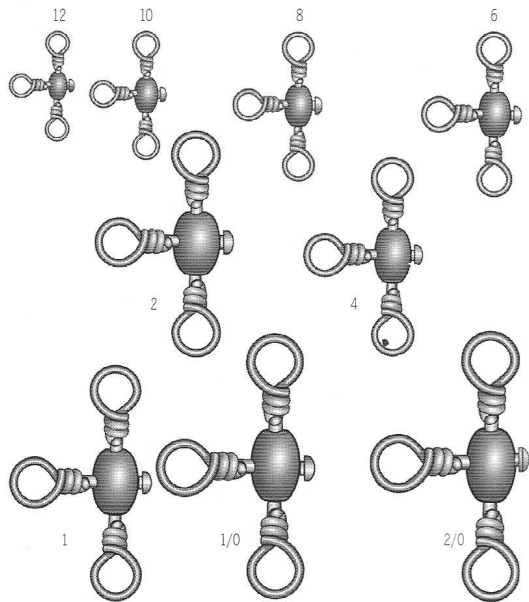

Crossline Swivels

These three-eye versions of the barrel swivel are great for sinker drops or fishing dual lines. Made of solid brass with twisted wire eyes.

NO. 1900SP (brass)
NO. 1900SPLK (black)
 Packed by varied piece count per size in a polybag on a color coded display card, 12 cards per inner box.

code	size	pcs./card	cards/case	approx. case wgt.
12	12	8	1,200	15 lbs.
10	10	8	1,200	18 lbs.
8	8	7	1,200	22 lbs.
6	6	6	1,200	25 lbs.
4	4	4	600	13 lbs.
2	2	3	600	14 lbs.
1*	1	3	600	15 lbs.
1/0*	1/0	2	600	13 lbs.
2/0*	2/0	2	600	25 lbs.

*Available in brass finish only.

Split-Rings

These extra strength, stainless steel split-rings are perfect for hook to lure connections. They can also be used to slide a swivel on the line.



NO. 2000SP (nickel)
 Packed by varied piece count per size in a polybag on a display card, 12 cards per inner box, 1,200 per case.

code	size	pcs./card	approx. case wgt.
1	1	10	11 lbs.
2	2	10	11 lbs.
3	3	10	12 lbs.
4	4	8	13 lbs.
5	5	5	13 lbs.
6	6	5	14 lbs.
7	7	4	15 lbs.
8	8	4	16 lbs.
9	9	2	14 lbs.

Dual Lock Snaps

Providing maximum strength with minimal weight, these one-piece, double locking, stainless steel snaps are quick and easy to use with lures and leaders. Rounded on both ends to keep the line and lure centered.



NO. SDLN (nickel)
NO. SDLB (black)
 Packed 10 pieces per polybag with full back header card, 12 cards per inner box, 480 per case.

code	size	approx. case wgt.
1	1	5 lbs.
2	2	6 lbs.
3	3	8 lbs.
4	4	10 lbs.
5	5	13 lbs.
6	6	17 lbs.

Connecting Links

The unique design of these extra strong, sure-lock connecting links make them perfect for surf and bottom fishing slider rigs. (Nickel-plated solid brass).

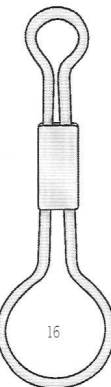

NO. CLNK
 Packed 5 pieces per polybag with full back header card, 12 cards per inner box, 480 per case.

code	size	approx. case wgt.
14	14	11 lbs.
16	16	17 lbs.

Crossline Swivel with Safety Snap

This three-eye version of the barrel swivel gives fishermen excellent "no-twist" protection for river drift fishing and bottom walking bait rigs. Available in a black finish, the sure-lock safety snap provides quick and easy sinker hook-up.



NO. 2900SPBLK-6 (black)
 Packed 6 per polybag on a display card, 12 per inner box, 600 per case. Approx. case wgt. 16 lbs.

Change-A-Hook Snaps

Change flies, lures and hooks the easy way with these strong, spring steel snaps. Simply snap them in or out.



NO. CHS9
 Packed 3 each of small, medium and large per polybag on a display card, 12 cards per inner box, 2,400 per case. Approx. case wgt. 11 lbs.

Sinker Slides with Safety Snaps

You'll feel the fish take the bait when you use these free-sliding sinker slides with safety snaps for attaching weight. Sensitivity and feel at the hook are not impaired by the sinker as the line slips freely through the plastic sleeve. The line may be wrapped around the T-tie to secure the sinker slide and sinker in a fixed position.

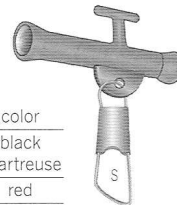

code	color
B	black
C	chartreuse
R	red

NO. SST
 Packed 2 per polybag on a display card, 12 cards per inner box, 1,200 per case.

code	size	tube length	snap size	approx. case wgt.
S	small	1"	2	13 lbs.
L	large	1-1/2"	5	16 lbs.

NO. SSTC (bulk) **100-Pack**
 Packed 100 per polybag with stick-on label.

code	size	snap size	pcs./case	approx. case wgt.
S	small	2	10,000	13 lbs.
L	large	5	10,000	34 lbs.

Sinker Slides with Connecting Links

These free-sliding sinker slides with connecting links for attaching weight are a must for surf and bottom fishing. You will know exactly when a fish has picked up the bait, as your line slips freely through the nylon sleeve, not impaired by the sinker.

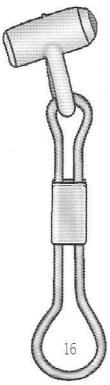

NO. SSCL
 Packed 2 per full back header card, 12 cards per inner box, 480 per case.

code	link size	approx. case wgt.
14	14	11 lbs.
16	16	17 lbs.

Sinker Slides with Dual Lock Snaps

You'll feel the fish take the bait when you use these free-sliding sinker slides with dual lock snaps for weight attachment. Sensitivity and feel at the hook are not impaired by the sinker as the line slips freely through the nylon sleeve. A must for surf and bottom fishing.



NO. SSDL
 Packed 2 per full back header card, 12 cards per inner box, 480 per case.

code	snap size	approx. case wgt.
3	3	5 lbs.
6	6	8 lbs.

Scissor Snap

These reliable and easy to use stainless steel scissor snaps are the best way to secure a connection with the "no-fail" scissor mechanism. Simply squeeze the middle of the snap and it opens, release, and you have attached your desired swivel, leader, or line. Available in 3 sizes.

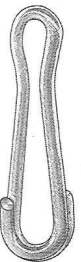

NO. SSSS (stainless steel)
NO. SSB (black)
 Packed 5 per polybag with full back header card, 12 per inner box, 576 per case.

code	snap size	approx. case wgt.
4	4	13 lbs.
5	5	18 lbs.
6	6	22 lbs.

1000-Pack

NO. SSBSS (stainless steel)
NO. SSB (black)
 Bulk packed 1000 per polybag with stick-on label.

code	size	approx. case wgt.
4	4	18 lbs.
5	5	27 lbs.
6	6	35 lbs.

1/4 oz. 3/8 oz. 1/2 oz. 5/8 oz. 3/4 oz. 1 oz.

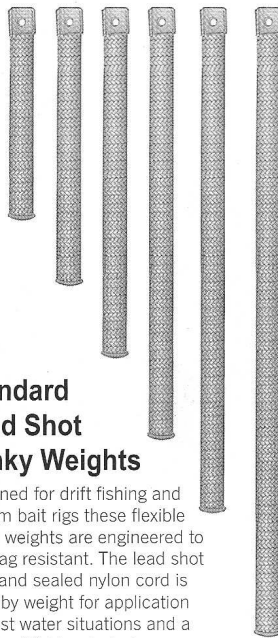

Standard Lead Shot Slinky Weights

Designed for drift fishing and bottom bait rigs these flexible slinky weights are engineered to be snag resistant. The lead shot filled and sealed nylon cord is sized by weight for application in most water situations and a variety of fishing techniques.

NO. SLW

Packed by varied piece count per size in a color coded zip-lock polybag, 12 bags per inner box, 144 per case.

code	weight	pcs./bag	approx. case wgt.
1/4	1/4 oz.	3	8 lbs.
3/8	3/8 oz.	3	11 lbs.
1/2	1/2 oz.	2	10 lbs.
5/8	5/8 oz.	2	12 lbs.
3/4	3/4 oz.	2	15 lbs.
1	1 oz.	2	18 lbs.

100-Pack

NO. SLWB

Packed 100 per bag, 1 bag per inner box.

code	weight	bags/case	approx. case wgt.
1/4	1/4 oz.	10	18 lbs.
3/8	3/8 oz.	10	24 lbs.
1/2	1/2 oz.	10	33 lbs.
5/8	5/8 oz.	10	42 lbs.
3/4	3/4 oz.	5	24 lbs.
1	1 oz.	5	33 lbs.

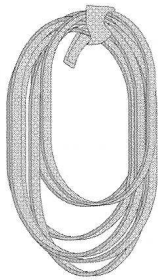

Slinky Cord

Made for production of slinky weights, this hollow core braided nylon cord works best with Danielson® slinky tube and ramrod and Danielson® lead slinky shot. Black in color and cut to 10-ft lengths this slinky cord is available in standard and magnum sizes.

NO. SLWC10S (standard)

Packed 1 coil per polybag with full back header card, 12 cards per inner box, 288 per case. Approx. case wgt. 12 lbs.

NO. SLWC10M (magnum)

Packed 1 coil per polybag with full back header card, 12 cards per inner box, 288 per case. Approx. case wgt. 19 lbs.

1/2 oz. 3/4 oz. 1 oz. 1-1/4 oz. 1-1/2 oz.

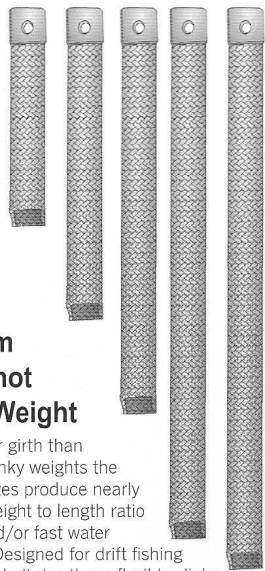

Magnum Lead Shot Slinky Weight

With a wider girth than standard slinky weights the magnum sizes produce nearly twice the weight to length ratio for deep and/or fast water situations. Designed for drift fishing and bottom bait rigs these flexible slinky weights are engineered to be snag resistant.

NO. SLWM

Packed 2 per size in a color coded zip-lock polybag, 12 bags per inner box, 144 per case.

code	weight	approx. case wgt.
1/2	1/2 oz.	11 lbs.
3/4	3/4 oz.	15 lbs.
1	1 oz.	20 lbs.
1-1/4	1-1/4 oz.	24 lbs.
1-1/2	1-1/2 oz.	30 lbs.

100-Pack

NO. SLWMB

Packed 100 per bag, 1 bag per inner box.

code	weight	bags/case	approx. case wgt.
1/2	1/2 oz.	10	33 lbs.
3/4	3/4 oz.	5	24 lbs.
1	1 oz.	5	33 lbs.
1-1/4	1-1/4 oz.	5	41 lbs.
1-1/2	1-1/2 oz.	5	49 lbs.

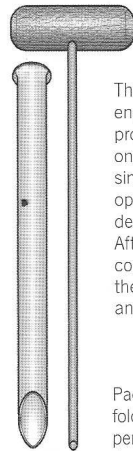

Slinky Tube with Ramrod

This slinky tube and ramrod are engineered for quick and efficient production of slinky weights. With one end of the slinky cord sealed simply insert the tube into the open end and fill with shot to the desired weight using the ramrod. After sealing the fill end of the cord attach swivel by means of the snap. Available in standard and magnum sizes.

NO. SLWTRS (standard)

NO. SLWTRM (magnum)

Packed 1 set per polybag with fold-over header card, 12 cards per inner box, 144 per case. Approx. case wgt. 12 lbs.

Lead Slinky Shot

Made specifically for production of slinky weights, this round lead shot works best with Danielson® slinky tube and ramrod and Danielson® slinky cord. Packaged in 5 lb. bags and available in standard and magnum sizes.

NO. SLWBSS (standard)

NO. SLWBSM (magnum)

Packed 5 lbs. per sealed polybag with stick-on label, 5 bags per case. Approx. case wgt. 26 lbs.



1/4 oz. 3/8 oz. 1/2 oz. 5/8 oz. 3/4 oz. 1 oz.



EnviroQuest® Standard Steel Shot Slinky Weights

Ideal for drift fishing and bottom bait rigs, these flexible slinky weights are snag resistant against rocks and weeds. Environmentally smart, the tough polypropylene cord is filled with steel shot.

NO. EQSW

Packed by varied piece count per size in a color coded zip-lock polybag, 12 bags per inner box, 144 per case.

code	weight	pcs./bag	approx. case wgt.
1/4	1/4 oz.	3	8 lbs.
3/8	3/8 oz.	3	11 lbs.
1/2	1/2 oz.	2	10 lbs.
5/8	5/8 oz.	2	12 lbs.
3/4	3/4 oz.	2	15 lbs.
1	1 oz.	2	18 lbs.

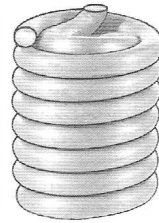

Solid Core Lead Wire

Perfect for stream and river drift fishing this solid lead wire comes in 3/16" and 1/4" sizes. Conveniently coiled in one pound spools.

Packed individually shrink-wrapped with a label, 25 per case.

NO.	wire diameter	approx. case wgt.
PL3161S	3/16"	26 lbs.
PL141S	1/4"	26 lbs.

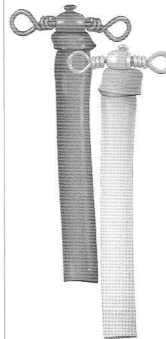

Lead Cinches

These top-quality lead cinches permit the release of lure and line should the lead wire sinker become snagged. Constructed with surgical grade latex tubing that is wrapped with a wire to a crossline swivel.

Packed 3 per blister card, 12 cards per inner box, 288 per case.

NO.	fits wire diameter	color	swivel size	approx. case wgt.
316LC	3/16"	amber	6	10 lbs.
316LCB	3/16"	black	6	10 lbs.
14LC	1/4"	amber	4	11 lbs.
14LCB	1/4"	black	4	11 lbs.

1/2 oz. 3/4 oz. 1 oz. 1-1/4 oz. 1-1/2 oz.

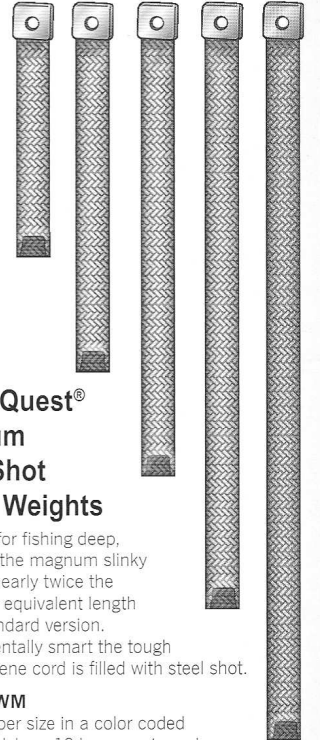

EnviroQuest® Magnum Steel Shot Slinky Weights

Designed for fishing deep, fast rivers the magnum slinky weight is nearly twice the weight per equivalent length as the standard version. Environmentally smart the tough polypropylene cord is filled with steel shot.

NO. EQSWM

Packed 2 per size in a color coded zip-lock polybag, 12 bags per inner box, 144 per case.

code	weight	approx. case wgt.
1/2	1/2 oz.	11 lbs.
3/4	3/4 oz.	15 lbs.
1	1 oz.	20 lbs.
1-1/4	1-1/4 oz.	25 lbs.
1-1/2	1-1/2 oz.	29 lbs.

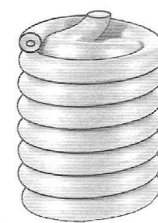

Hollow Core Lead Wire

Perfect for stream and drift fishing this hollow core lead wire comes in 3/16" and 1/4" sizes. Conveniently coiled in one pound spools.

Packed individually shrink-wrapped with a label, 25 per case.

NO.	wire diameter	approx. case wgt.
PL3161H	3/16"	25 lbs.
PL141H	1/4"	29 lbs.

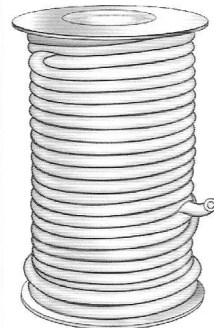

Latex Tubing

Spooled in 50' rolls, this surgical grade latex tubing is used with lead cinches, snubbers and even sling shots. Available in amber or black to fit 3/16" or 1/4" lead wire.

Packed 1 roll per dispenser box, 40 per case.

NO.	fits wire diameter	color	approx. case wgt.
RT316A	3/16"	amber	39 lbs.
RT316B	3/16"	black	39 lbs.
RT250A	1/4"	amber	45 lbs.
RT250B	1/4"	black	45 lbs.

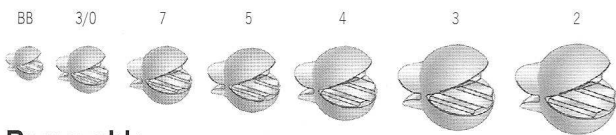

Removable Split-Shot Sinkers

Especially helpful when a small amount or slight variation of weight is required, these split-shot sinkers feature an easy on and off application. Just squeeze the jaws to attach and the neck lever to remove. The grip-lock jaw holds firm without damaging the line.

NO. SS

Packed by varied piece count per size in a color coded zip-lock polybag, 12 bags per inner box, 144 per case.

code	size	pcs./bag	approx. case wgt.
BB	BB	60	10 lbs.
3/0	3/0	40	11 lbs.
7	7	30	18 lbs.
5	5	20	15 lbs.
4	4	15	16 lbs.
3	3	11	17 lbs.
2	2	7	18 lbs.

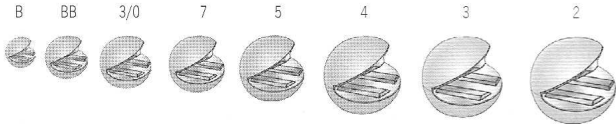

Round Split-Shot Sinkers

A great sinker for those times when weeds present a frustrating snagging problem or when just a small amount or variation in weight is needed. The soft lead tightly grips the line without damaging it. Simply squeeze with your fingers to apply.

NO. RS

Packed by varied piece count per size in a color coded zip-lock polybag, 12 bags per inner box, 144 per case.

code	size	pcs./bag	approx. case wgt.
B	B	60	9 lbs.
BB	BB	60	13 lbs.
3/0	3/0	40	12 lbs.
7	7	30	16 lbs.
5	5	20	17 lbs.
4	4	15	18 lbs.
3	3	11	19 lbs.
2	2	7	15 lbs.

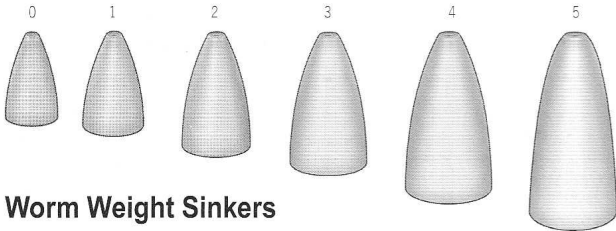

Worm Weight Sinkers

Perfect for rubber worms, the deep tunnel base of these weights secure the worm nose and protect it from snags and tears. Their streamline shape allows them to slip through weeds and over rocks.

NO. WS

Packed by varied piece count per size in a color coded zip-lock polybag, 12 bags per inner box, 144 per case.

code	size	weight	pcs./bag	approx. case wgt.
0	0	1/16 oz.	16	11 lbs.
1	1	1/8 oz.	13	15 lbs.
2	2	3/16 oz.	10	19 lbs.
3	3	1/4 oz.	8	20 lbs.
4	4	3/8 oz.	6	21 lbs.
5	5	1/2 oz.	4	20 lbs.

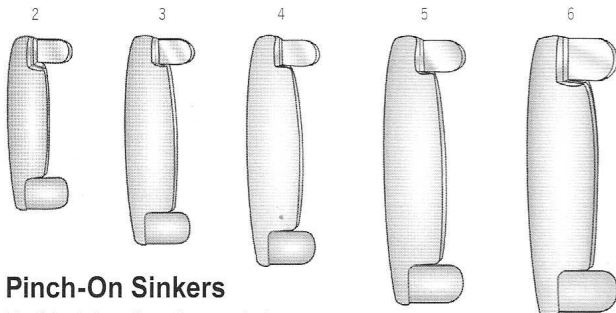

Pinch-On Sinkers

Flexible tabs allow these pinch-on sinkers to be put on and taken off easily without disturbing other tackle. A deep groove slot firmly holds the line, and the streamline shape permits the sinker to negotiate through weeds and over rocks.

NO. PO

Packed by varied piece count per size in a color coded zip-lock polybag, 12 bags per inner box, 144 per case.

code	size	weight	pcs./bag	approx. case wgt.
2	2	1/8 oz.	10	12 lbs.
3	3	3/16 oz.	8	19 lbs.
4	4	1/4 oz.	6	16 lbs.
5	5	3/8 oz.	4	17 lbs.
6	6	1/2 oz.	3	15 lbs.

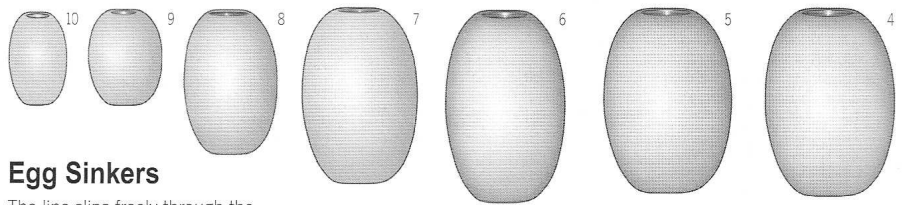

Egg Sinkers

The line slips freely through the center hole of these egg sinkers to allow sensitivity and feel at the hook. Primarily used for bottom fishing, their egg shape permits the sinker to slide through weeds and over rocks.

NO. ES

Packed by varied piece count per size in a color coded zip-lock polybag, 12 bags per inner box, 144 per case.

code	size	weight	pcs./bag	approx. case wgt.
10	10	1/8 oz.	10	13 lbs.
9	9	1/4 oz.	7	16 lbs.
8	8	1/2 oz.	5	23 lbs.
7	7	3/4 oz.	3	23 lbs.
6	6	1 oz.	2	20 lbs.
5	5	1-1/4 oz.	2	25 lbs.
4	4	1-1/2 oz.	2	28 lbs.

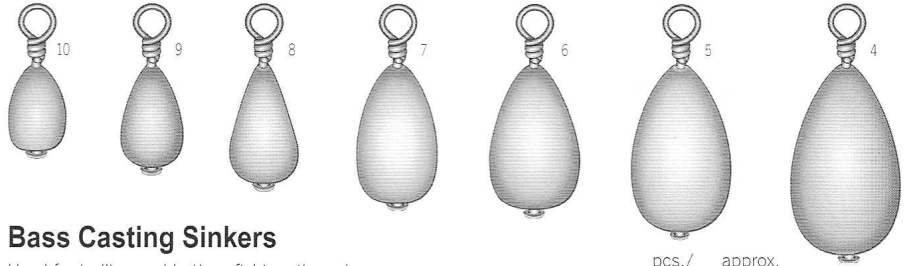

Bass Casting Sinkers

Used for trolling and bottom fishing, these bass casting sinkers have a swiveling brass eyelet that makes them superb for fishing in strong currents and over rocks. Ideal for sinker drops and three-line hook-ups.

NO. BS

Packed by varied piece count per size in a color coded zip-lock polybag, 12 bags per inner box, 144 per case.

code	size	weight	pcs./bag	approx. case wgt.
10	10	1/8 oz.	5	7 lbs.
9	9	3/16 oz.	5	9 lbs.
8	8	1/4 oz.	4	10 lbs.
7	7	3/8 oz.	4	16 lbs.
6	6	1/2 oz.	3	15 lbs.
5	5	3/4 oz.	2	15 lbs.
4	4	1 oz.	2	19 lbs.

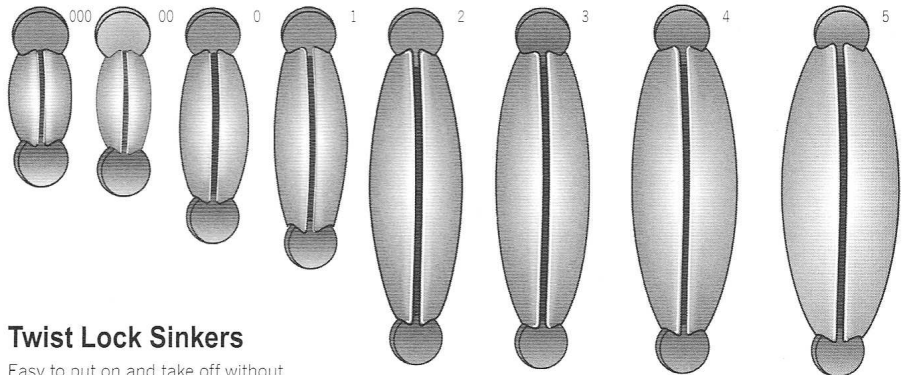

Twist Lock Sinkers

Easy to put on and take off without disturbing other tackle, these rubber core sinkers guard against line damage. They fit snugly against the line by simply twisting their rubber ears.

NO. TL

Packed by varied piece count per size in a color coded zip-lock polybag, 12 bags per inner box, 144 per case.

code	size	weight	pcs./bag	approx. case wgt.
000	000	1/16 oz.	8	7 lbs.
00	00	1/8 oz.	6	8 lbs.
0	0	1/4 oz.	5	13 lbs.
1	1	3/8 oz.	4	15 lbs.
2	2	1/2 oz.	3	14 lbs.
3	3	3/4 oz.	3	23 lbs.
4	4	1 oz.	2	19 lbs.
5	5	1-1/16 oz.	2	21 lbs.

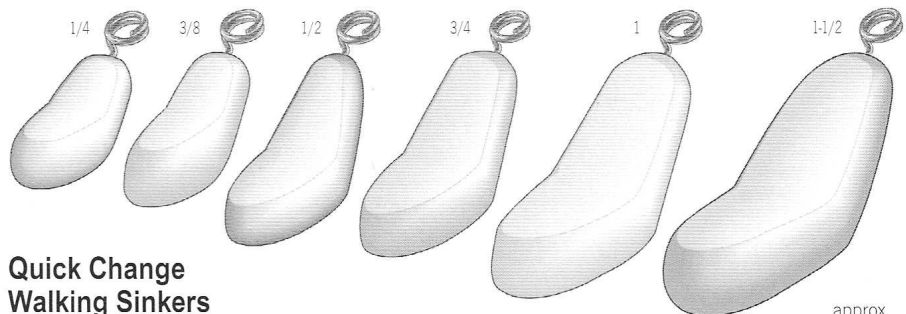

Quick Change Walking Sinkers

Designed to slide freely on the line to keep bait off the bottom and to resist snags. These walking sinkers feature a unique quick change, no-tie eyelet.

NO. SWS

Packed by varied piece count per size in a color coded zip-lock polybag, 12 bags per inner box, 144 per case.

code	weight	pcs./bag	approx. case wgt.
1/4	1/4 oz.	10	25 lbs.
3/8	3/8 oz.	8	29 lbs.
1/2	1/2 oz.	7	33 lbs.
3/4	3/4 oz.	6	43 lbs.
1	1 oz.	5	47 lbs.
1-1/2	1-1/2 oz.	4	55 lbs.

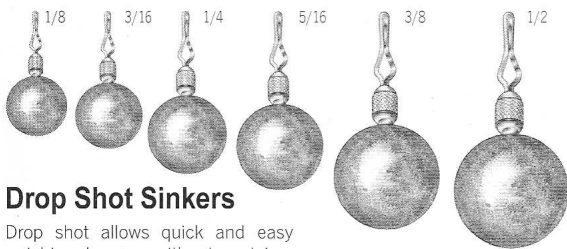

Drop Shot Sinkers

Drop shot allows quick and easy weight change without retying. Simply tie a knot at the end of your line, run it through the eye of the swivel and pull tight. The line wedges itself in the V-shaped eye for a secure hold.

NO. DSR

Packed by varied piece count per size on a blister card, 12 cards per inner box, 144 per case.

code	weight	pcs./ card	approx. case wgt.
18	1/8 oz.	7	10 lbs.
316	3/16 oz.	6	11 lbs.
14	1/4 oz.	6	16 lbs.
516	5/16 oz.	5	18 lbs.
38	3/8 oz.	5	20 lbs.
12	1/2 oz.	4	21 lbs.

Tungsten Drop Shot Sinkers

For finesse drop shot situations ultra dense tungsten provides the desired weight with much less mass than lead. Special V-shaped eye allows you to change weight without retying. Simply tie a knot at the end of your line, run it through the swivel, pull up and tight and you're ready to fish.

NO. DSTR

Packed by varied piece count per size on a blister card, 12 cards per inner box, 144 per case.

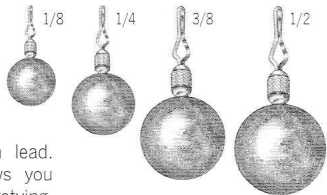

code	weight	pcs./ card	approx. case wgt.
18	1/8 oz.	8	12 lbs.
14	1/4 oz.	4	12 lbs.
38	3/8 oz.	3	13 lbs.
12	1/2 oz.	2	12 lbs.

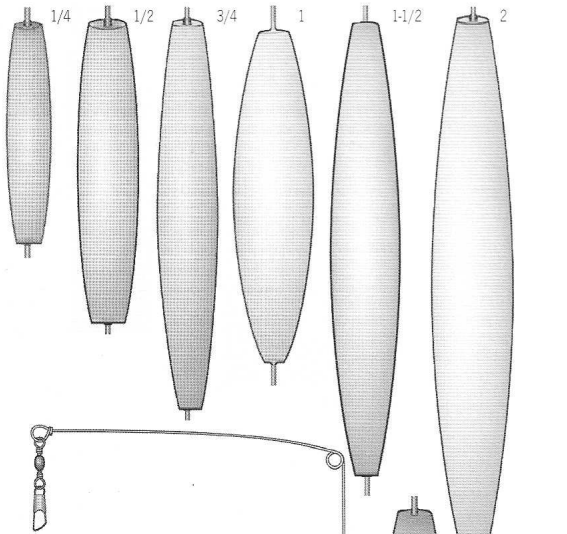

Bottom Walking Sinkers

These bottom walking sinkers eliminate snagging when you're trolling or drifting with live bait or a lure. Feel the bottom of the lake or river without annoying hang-ups by walking your line and bait over snags, rocks and weeds. They also improve bait action. Choose from several different weights, each on a 12" leg with a 4-1/2" arm and snap swivel for mainline hook-up.

NO. SBW

Packed 2 per polybag with header card, 12 cards per inner box.

code	weight	cards/ case	approx. case wgt.
1/4	1/4 oz.	240	18 lbs.
1/2	1/2 oz.	240	27 lbs.
3/4	3/4 oz.	240	31 lbs.
1	1 oz.	240	37 lbs.
1-1/2	1-1/2 oz.	120	26 lbs.
2	2 oz.	120	33 lbs.
2-1/2	2-1/2 oz.	120	45 lbs.
3	3 oz.	120	51 lbs.

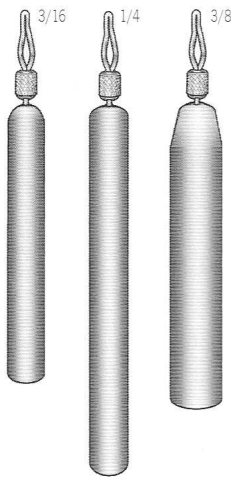

Pencil Drop Shot Sinkers

Special line-gripping V-shaped eye allows you to change drop shot weight without retying. Simply tie a knot at the end of your line, run it through the swivel, pull up and tight and you're ready to fish.

NO. DSP

Packed by varied piece count per size on a blister card, 12 cards per inner box, 144 per case.

code	weight	pcs./ bag	approx. case wgt.
316	3/16 oz.	6	12 lbs.
14	1/4 oz.	6	17 lbs.
38	3/8 oz.	5	21 lbs.

Twist-On Line Sinkers

Designed for convenience, these lead strips easily twist on and off your line. Simply tear a strip out as you would a match and wrap it around line or hook. Attach one or more or even a partial strip to achieve the weight desired.

NO. TOLS

Packed 1 matchbook dispenser per polybag with insert card, 24 cards per inner box, 240 per case. Approx. case wgt. 11 lbs.

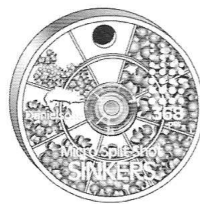

Micro Split-Shot

Ideal for any fishing situation that requires a slight amount or small variation in weight. Choose from seven micro sizes of split-shot in this 368-piece dial box selector.

NO. MS368

Packed 1 assortment per selector, 12 selectors per inner box, 144 per case. Approx. case wgt. 24 lbs.



Removable Split-Shot

Four popular sizes of removable split-shot sinkers are showcased in this 78-piece dial box selector. Sinkers feature an easy on and off application and they tightly grip the line without damaging it.

NO. RSSD78

Packed 1 assortment per selector, 12 selectors per inner box, 144 per case. Approx. case wgt. 34 lbs.



Removable Split-Shot

Five popular sizes of removable split-shot are showcased in this 124-piece dial box selector. Sinkers feature easy on and off application and grip lock jaws.

NO. RSSD124

Packed 1 assortment per selector, 12 selectors per inner box, 72 per case. Approx. case wgt. 32 lbs.



Egg Sinkers and Split-Shot

You'll be outfitted for bottom fishing with the 23 free sliding egg sinkers in various weights in this dial box selector. Included are 32 split-shot in assorted sizes for use as sinker stops.

NO. ADESS5

Packed 1 assortment per selector, 12 selectors per inner box, 72 per case. Approx. case wgt. 38 lbs.

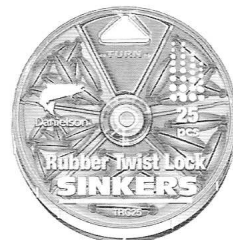

Rubber Core Twist Lock Sinkers

This dial box assortment contains 25 rubber twist lock sinkers in five popular sizes. They're easy to put on and take off with just a twist of their rubber ears.

NO. TRC25

Packed 1 assortment per selector, 12 selectors per inner box, 72 per case. Approx. case wgt. 27 lbs.



Round Split-Shot

Four popular sizes of round split-shot sinkers are featured in this 78-piece dial box selector. Split-shot is great whenever you need a slight variation of weight.

NO. RS78

Packed 1 assortment per selector, 12 selectors per inner box, 144 per case. Approx. case wgt. 31 lbs.

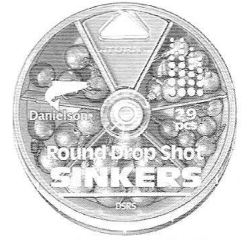

Drop Shot Sinkers

Five sizes of round drop shot sinkers are featured in this 29-piece dial box selector. The line wedges itself in the V-shaped eye for quick and easy weight change without retying.

NO. DSRS

Packed 1 assortment per selector, 12 selectors per inner box, 72 per case. Approx. case wgt. 40 lbs.



Bass Casting Sinkers

Ideal for sinker drops and three-line hook-ups, this dial box selector features 27 bass casting sinkers with swiveling brass eyelets. Comes in five popular sizes.

NO. BC27

Packed 1 assortment per selector, 12 selectors per inner box, 72 per case. Approx. case wgt. 37 lbs.



Worm Weight Sinkers

Choose from 29 worm weight sinkers in five popular sizes in this dial box selector. These sinkers easily slip through weeds and over rocks to protect the worm from snags and tears.

NO. WS29

Packed 1 assortment per selector, 12 selectors per inner box, 72 per case. Approx. case wgt. 29 lbs.

Bank Sinkers

Used from a boat, pier and the shore, these bank sinkers are especially popular with bottom fishermen. Designed specifically to prevent snags, these bank sinkers feature a molded eye in the head of the sinker.

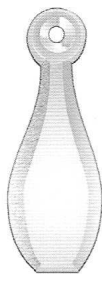

NO. 125B

Bulk packed by varied piece count per size in a polybag with stick on label, 5 bags per case.

code	weight	pcs./ bag	pcs./ case	approx. case wgt.
1/2	1/2 oz.	160	800	27 lbs.
3/4	3/4 oz.	107	535	28 lbs.
1	1 oz.	80	400	27 lbs.
1-1/2	1-1/2 oz.	54	270	28 lbs.
2	2 oz.	40	200	27 lbs.
3	3 oz.	27	135	28 lbs.
4	4 oz.	20	100	27 lbs.
5	5 oz.	16	80	27 lbs.
6	6 oz.	14	70	29 lbs.
8	8 oz.	10	50	27 lbs.
10	10 oz.	8	40	27 lbs.
12	12 oz.	7	35	29 lbs.
14	14 oz.	6	30	29 lbs.
16	16 oz.	5	25	27 lbs.

Packaged Bank Sinkers

Used for bottom fishing, the bank sinker's bowling pin shape is designed to resist snags. Molded-in eye allows for quick and easy hookup.

NO. 125PB

Packed by varied piece count per size in a polybag with stick-on label, and by varied number of bags per shelf display box.

code	weight	pcs./ bag	bags/ box	bags/ case	approx. case wgt.
1/2	1/2 oz.	4	72	144	20 lbs.
3/4	3/4 oz.	4	56	112	23 lbs.
1	1 oz.	4	48	96	26 lbs.
1-1/2	1-1/2 oz.	4	36	72	29 lbs.
2	2 oz.	4	28	56	30 lbs.
3	3 oz.	3	24	48	29 lbs.
4	4 oz.	2	28	56	30 lbs.
5	5 oz.	2	24	48	32 lbs.
6	6 oz.	2	20	40	32 lbs.
8	8 oz.	2	16	32	34 lbs.
10	10 oz.	2	10	20	27 lbs.
12	12 oz.	1	18	36	29 lbs.
16	16 oz.	1	14	28	30 lbs.



Packaged Dollar Sinkers

Designed for bottom fishing, these dollar sinkers are concave on both sides to hold in current and surf and feature a molded-in brass eye.

NO. DSPB

Packed by varied piece count per size in a polybag with stick-on label, and by varied number of bags per shelf display box.

code	weight	pcs./ bag	bags/ box	bags/ case	approx. case wgt.
1	1 oz.	6	26	52	22 lbs.
2	2 oz.	4	25	50	27 lbs.
3	3 oz.	3	23	46	28 lbs.
4	4 oz.	2	20	40	32 lbs.

Pyramid Sinkers

These sharp pointed, pyramid sinkers are designed to hold in current or surf, in either sandy or rocky environments. They feature a heavy brass eye molded into each sinker and are flat sided.

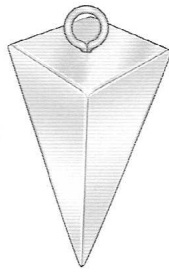

NO. 345B

Bulk packed by varied piece count per size in a polybag with stick on label, 5 bags per case.

code	weight	pcs./ bag	pcs./ case	approx. case wgt.
1	1 oz.	80	400	27 lbs.
2	2 oz.	40	200	27 lbs.
3	3 oz.	27	135	28 lbs.
4	4 oz.	20	100	27 lbs.
5	5 oz.	16	80	27 lbs.
6	6 oz.	14	70	29 lbs.
8	8 oz.	10	50	27 lbs.
10	10 oz.	8	40	27 lbs.
12	12 oz.	7	35	29 lbs.
16	16 oz.	5	25	27 lbs.
20	20 oz.	4	20	27 lbs.
24	24 oz.	4	20	32 lbs.

Packaged Pyramid Sinkers

NO. 345PB

Packed by varied piece count per size in a polybag with stick-on label, and by varied number of bags per shelf display box.

code	weight	pcs./ bag	bags/ box	bags/ case	approx. case wgt.
1	1 oz.	4	32	64	18 lbs.
2	2 oz.	4	24	48	26 lbs.
3	3 oz.	3	25	50	30 lbs.
4	4 oz.	2	28	56	30 lbs.
5	5 oz.	2	22	44	30 lbs.
6	6 oz.	2	18	36	29 lbs.
8	8 oz.	2	15	30	32 lbs.
10	10 oz.	2	9	18	25 lbs.
12	12 oz.	1	18	36	29 lbs.
16	16 oz.	1	14	28	30 lbs.
20	20 oz.	1	10	20	27 lbs.
24	24 oz.	1	9	18	29 lbs.

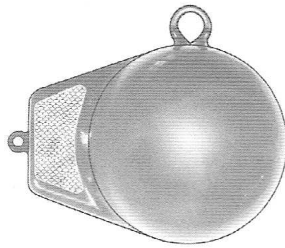

Vinyl-Coated Downrigger Weights

Effective at getting your lure to the right depth this downrigger weight is designed with a keel to ensure accurate tracking and to prevent cable twisting. Reflective prism tape is attached to both sides of the keel for sparkle and flash. Vinyl coating protects both boat and downrigger weight.

NO. DWV

Individually packed 1 each with a hang tag in a cardboard box.

code	weight	pcs./ case	approx. case wgt.
4	4 lb.	8	33 lbs.
6	6 lb.	4	27 lbs.
8	8 lb.	4	35 lbs.
10	10 lb.	4	40 lbs.
12	12 lb.	4	51 lbs.
15	15 lb.	2	33 lbs.

Cannon Ball Sinkers

Cannon ball sinkers are great for getting big bait down deep. They feature a heavy-duty, molded-in brass eye that easily attaches to line, swivel or sinker release.



NO. CBB

Bulk packed by varied piece count per size in a polybag with stick on label, 5 bags per case.

code	weight	pcs./ bag	pcs./ case	approx. case wgt.
1/2	1/2 oz.	160	800	27 lbs.
3/4	3/4 oz.	107	535	28 lbs.
1	1 oz.	80	400	27 lbs.
1-1/2	1-1/2 oz.	54	270	28 lbs.
2	2 oz.	40	200	27 lbs.
3	3 oz.	27	135	28 lbs.
4	4 oz.	20	100	27 lbs.
5	5 oz.	16	80	27 lbs.
6	6 oz.	14	70	29 lbs.
8	8 oz.	10	50	27 lbs.
10	10 oz.	8	40	27 lbs.
12	12 oz.	7	35	29 lbs.
16	16 oz.	5	25	27 lbs.
20	20 oz.	4	20	34 lbs.
24	24 oz.	4	20	32 lbs.
32	32 oz.	3	15	32 lbs.
40	40 oz.	2	10	27 lbs.
48	48 oz.	2	10	32 lbs.

Packaged Cannon Ball Sinkers

NO. CBPB

Packed by varied piece count per size in a polybag with stick-on label, and by varied number of bags per shelf display box.

code	weight	pcs./ bag	bags/ box	bags/ case	approx. case wgt.
1/2	1/2 oz.	4	58	116	17 lbs.
3/4	3/4 oz.	4	44	88	19 lbs.
1	1 oz.	4	34	68	19 lbs.
1-1/2	1-1/2 oz.	4	34	68	28 lbs.
2	2 oz.	4	28	56	30 lbs.
3	3 oz.	3	20	40	25 lbs.
4	4 oz.	2	24	48	26 lbs.
5	5 oz.	2	20	40	27 lbs.
6	6 oz.	2	20	40	32 lbs.
8	8 oz.	2	17	34	36 lbs.
10	10 oz.	1	26	52	35 lbs.
12	12 oz.	1	20	40	32 lbs.
16	16 oz.	1	15	30	32 lbs.
20	20 oz.	1	10	20	27 lbs.
24	24 oz.	1	8	16	27 lbs.
32	32 oz.	1	8	16	34 lbs.
40	40 oz.	1	6	12	32 lbs.
48	48 oz.	1	5	10	32 lbs.

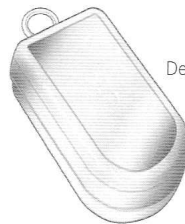

Cod Weights

Designed with a tapered nose to ensure quick deployment, this cod weight is excellent for fishing in deep water and or fast currents. Available in 5 sizes.

NO. CW

Packed 1 each per polybag with stick-on label.

code	weight	pcs./ case	approx. case wgt.
1	1 lb.	25	27 lbs.
2	2 lb.	12	26 lbs.
3	3 lb.	8	20 lbs.
4	4 lb.	6	26 lbs.
5	5 lb.	5	27 lbs.

Vinyl-Coated Cannon Ball Sinkers

These vinyl-coated cannon ball sinkers feature a heavy-duty, molded-in brass eye that easily attaches to line, swivel or sinker release. Ideal for getting big bait down deep.

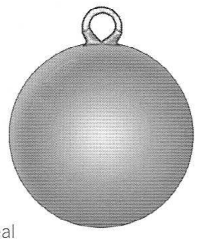

NO. CBVB

Bulk packed by varied piece count per size in a polybag with stick on label, 5 bags per case.

code	weight	pcs./ bag	pcs./ case	approx. case wgt.
1	1 oz.	80	400	27 lbs.
1-1/2	1-1/2 oz.	54	270	28 lbs.
2	2 oz.	40	200	27 lbs.
2-1/2	2-1/2 oz.	32	160	29 lbs.
3	3 oz.	27	135	28 lbs.
4	4 oz.	20	100	27 lbs.
16	16 oz.	5	25	27 lbs.
32	32 oz.	3	15	32 lbs.

Packaged Vinyl-Coated Cannon Ball Sinkers

NO. CBVPB

Packed by varied piece count per size in a polybag with stick-on label, and by varied number of bags per shelf display box.

code	weight	pcs./ bag	bags/ box	bags/ case	approx. case wgt.
1	1 oz.	4	34	68	19 lbs.
1-1/2	1-1/2 oz.	4	34	68	28 lbs.
2	2 oz.	4	28	56	30 lbs.
2-1/2	2-1/2 oz.	3	24	48	25 lbs.
3	3 oz.	3	20	40	25 lbs.
4	4 oz.	2	24	48	26 lbs.
16	16 oz.	1	15	30	32 lbs.
32	32 oz.	1	8	16	34 lbs.

Weight Cradle

Great for storing downrigger balls and pancake weights, the weight cradle keeps your weights from slamming into the inside of the boat when you are not using them.

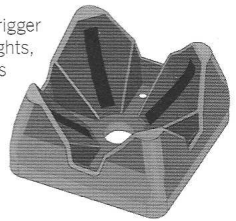

NO. DWVC

Packed 2 each shrink-wrapped with insert card, 48 per case. Approx. case wgt. 48 lbs.

Vinyl-Coated Pancake Weights

The unique design of these vinyl-coated weights feature a large fin for smooth drag and tracking. Reflective prism tape on both sides add sparkle and flash for attracting fish. Available in 4 sizes.

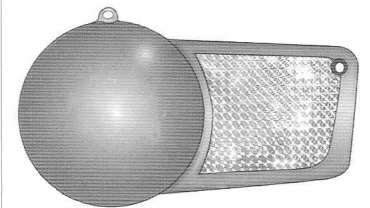

NO. PWB

Individually packed 1 each with a stick-on label in a cardboard box.

code	weight	pcs./ case	approx. case wgt.
8	8 lb.	4	33 lbs.
10	10 lb.	3	32 lbs.
12	12 lb.	2	37 lbs.
15	15 lb.	2	32 lbs.

Spin Sinkers

Used for trolling and mooching in both fresh and saltwater, these crescent-shaped spin sinkers feature a stainless steel bead chain swivel and nickel crane swivel that prevent the line from twisting. Swivels are attached to eyes cast into each end of the sinker.

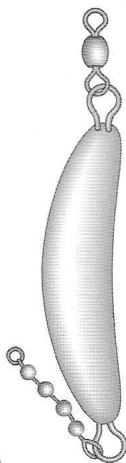

NO. 235

NO. 235CH (chartreuse)

NO. 235FR (fluorescent red)

Bulk packed 12 each per polybag with stick on label.

code	weight	pcs./case	approx. case wgt.
0.50*	1/2 oz.	720	24 lbs.
1	1 oz.	360	24 lbs.
1.5*	1-1/2 oz.	240	24 lbs.
2	2 oz.	180	24 lbs.
2.5*	2-1/2 oz.	144	24 lbs.
3	3 oz.	120	24 lbs.
3.5*	3-1/2 oz.	108	25 lbs.
4	4 oz.	96	25 lbs.
5	5 oz.	72	24 lbs.
6	6 oz.	60	24 lbs.
8*	8 oz.	48	25 lbs.
10*	10 oz.	36	24 lbs.
12*	12 oz.	24	20 lbs.
16*	16 oz.	24	25 lbs.

* available in natural finish only

Packaged Spin Sinkers

NO. 235PB

NO. 235CHPB (chartreuse)

NO. 235FRPB (fluorescent red)

Packed by varied piece count per size in a polybag with stick-on label, and by varied number of bags per shelf display box.

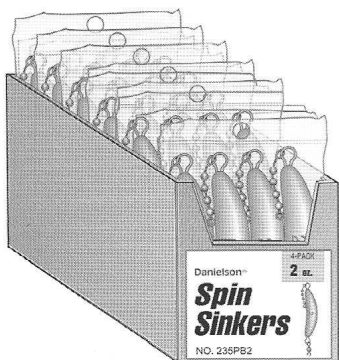

code	weight	pcs./bag	bags/box	bags/case	approx. case wgt.
1/2*	1/2 oz.	4	54	108	16 lbs.
1	1 oz.	4	44	88	24 lbs.
1-1/2*	1-1/2 oz.	4	36	72	29 lbs.
2	2 oz.	4	28	56	30 lbs.
3	3 oz.	3	28	56	34 lbs.
4	4 oz.	2	28	56	30 lbs.
5	5 oz.	2	22	44	30 lbs.
6	6 oz.	2	18	36	29 lbs.
8*	8 oz.	2	14	28	30 lbs.
10*	10 oz.	1	24	48	32 lbs.
12*	12 oz.	1	18	36	29 lbs.
16*	16 oz.	1	16	32	28 lbs.

* available in natural finish only

EnviroQuest®

Environmentally Smart Fishing Weights

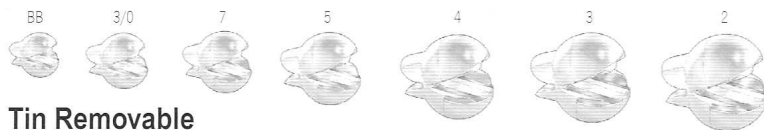

Tin Removable Split-Shot Sinkers

Environmentally smart, these tin split-shot sinkers are the quick and easy way to add or change weight. Simply close the jaws to attach and squeeze the neck lever to remove. The grip-lock jaw holds firm without damaging the line.

NO. EQSS

Packed by varied piece count per size in a color coded zip-lock polybag, 12 bags per inner box, 144 per case.

code	size	pcs./bag	approx. case wgt.
BB	BB	45	6 lbs.
3/0	3/0	30	7 lbs.
7	7	17	7 lbs.
5	5	14	7 lbs.
4	4	10	7 lbs.
3	3	7	8 lbs.
2	2	5	9 lbs.

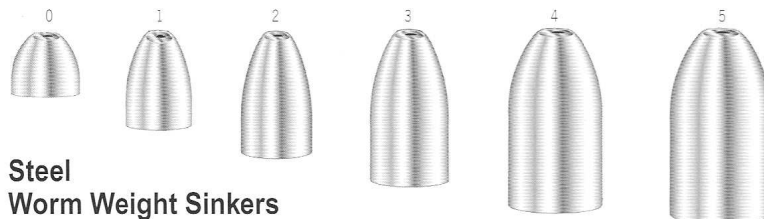

Steel Worm Weight Sinkers

Designed for use with worms and baits these environmentally smart steel weights feature a streamlined bullet shape for slipping through weeds and over rocks. Deep concave tunnel base protects bait from snags and damage.

NO. EQWW

Packed by varied piece count per size in a color coded zip-lock polybag, 12 bags per inner box, 144 per case.

code	size	weight	pcs./bag	approx. case wgt.
0	0	1/16 oz.	15	10 lbs.
1	1	1/8 oz.	12	15 lbs.
2	2	3/16 oz.	10	20 lbs.
3	3	1/4 oz.	9	22 lbs.
4	4	3/8 oz.	7	26 lbs.
5	5	1/2 oz.	5	24 lbs.

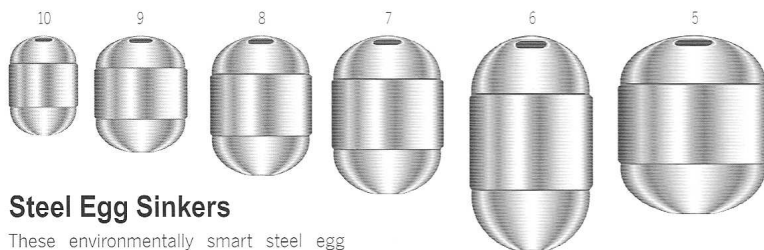

Steel Egg Sinkers

These environmentally smart steel egg sinkers are designed to preserve sensitivity and feel at the hook by permitting the line to pass through freely. Terrific for bottom fishing, their oval shape allows the sinker to slide through weeds and over rocks.

NO. EQES

Packed by varied piece count per size in a color coded zip-lock polybag, 12 bags per inner box, 144 per case.

code	size	weight	pcs./bag	approx. case wgt.
10	10	1/8 oz.	14	18 lbs.
9	9	1/4 oz.	9	22 lbs.
8	8	3/8 oz.	7	26 lbs.
7	7	1/2 oz.	5	24 lbs.
6	6	3/4 oz.	4	29 lbs.
5	5	1 oz.	3	29 lbs.



Steel Bass Casting Sinkers

With a *swiveling brass eyelet these environmentally smart steel bass casting sinkers are perfect for fishing in strong currents and over rocks. Great for casting, trolling and bottom fishing or any technique using a swivel attached weight.

NO. EQBC

Packed by varied piece count per size in a color coded zip-lock polybag, 12 bags per inner box, 144 per case.

code	size	weight	pcs./bag	approx. case wgt.
10	10	1/8 oz.	8	11 lbs.
9	9	3/16 oz.	7	13 lbs.
8	8	1/4 oz.	6	15 lbs.
7	7	3/8 oz.	5	19 lbs.
6	6	1/2 oz.	4	20 lbs.
5	5	3/4 oz.	3	22 lbs.
4	4	1 oz.	2	20 lbs.

Tin Removable Split-Shot

Four popular sizes of environmentally smart removable tin split-shot sinkers are featured in this 78-piece dial box selector. Simply close the grip-lock jaws to attach and squeeze the neck lever to remove.



NO. EQSS78

Packed 1 assortment per selector, 12 selectors per inner box, 144 per case. Approx. case wgt. 34 lbs.

size	pcs.
3/0	36
7	18
5	14
4	10

Steel Worm Weights

This 35-piece dial box selector features five popular sizes of environmentally smart steel worm weights.

Designed for use with worms and baits its streamlined bullet shape slips through weeds and over rocks.

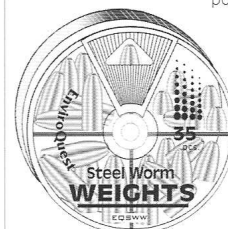

NO. EQSWW

Packed 1 assortment per selector, 12 selectors per inner box, 72 per case.

size	wgt.	pcs.
0	1/16 oz.	7
1	1/8 oz.	10
2	3/16 oz.	8
3	1/4 oz.	6
4	3/8 oz.	4

Steel Egg Sinkers

This 27-piece dial box selector features four popular sizes of environmentally smart egg sinkers.

Designed to preserve sensitivity and feel at the hook by permitting the line to pass through freely.

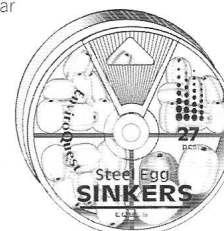

NO. EQSES

Packed 1 assortment per selector, 12 selectors per inner box, 72 per case. Approx. case wgt. 36 lbs.

size	wgt.	pcs.
10	1/8 oz.	7
9	1/4 oz.	10
8	3/8 oz.	7
7	1/2 oz.	3

Steel Bass Casting Sinkers

Five popular sizes of environmentally smart steel bass casting sinkers are featured in this 27-piece dial box selector. The swiveling brass eyelet makes these sinkers perfect for fishing in strong currents and over rocks.



size	wgt.	pcs.
10	1/8 oz.	8
9	3/16 oz.	8
8	1/4 oz.	4
7	3/8 oz.	4
6	1/2 oz.	3

NO. EQSBC

Packed 1 assortment per selector, 12 selectors per inner box, 72 per case. Approx. case wgt. 33 lbs.

Round Beads

Perfect for making or modifying lures and rigs. These top quality plastic beads are available in a full range of sizes from 4 to 8 millimeters, and in fluorescent and luminous colors.

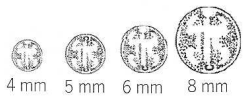

code	color
C	chartreuse
FO	fluorescent orange
FR	fluorescent red
L	luminous

NO. BDS

Packed by varied piece count per size in a polybag on a display card, 24 cards per inner box, 576 per case.

Fluorescent Colors

code	size	pcs./ bag	approx. case wgt.
4	4 mm	110	10 lbs.
5	5 mm	90	12 lbs.
6	6 mm	65	14 lbs.
8	8 mm	35	17 lbs.

Luminous Color

code	size	pcs./ bag	approx. case wgt.
6	6 mm	30	10 lbs.
8	8 mm	15	11 lbs.

Rattle Beads

These floating rattle beads call fish in with ticks and clatter created by the slightest motion. Simply slide rattle beads onto Carolina spinner or any rig for added noise and color. Available in 6mm round in brilliant and luminous colors.

code	color
C	chartreuse
FR	fluorescent red
L	luminous
LM	lime

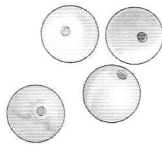

NO. BDR6

Packed 15 pieces (luminous 13 pieces) per polybag with header card, 24 cards per inner box, 576 per case. Approx. case wgt. 12 lbs.

Bobber

Stop Knots with Beads

Fished with a slip float and assisted by a bead the bobber stop knot is used to set desired bait depth. Easy to use, simply run the line through the tube, push the knot onto the line, then tighten, trim and set to desired depth.

NO. BSTP

Packed 3 per polybag with full back header card, 12 cards per box, 1,200 per case. Approx. case wgt. 10 lbs.

NO. BSTPMB (carded) 25-Pack

Packed 25 per polybag with full back header card, 12 cards per box, 600 per case. Approx. case wgt. 11 lbs.

Rubber Bobber/Sinker Stops

These innovative stops are ideal for slip floats or adjustable sinker rigs. The soft rubber stop grips monofilament line securely without crimping or causing damage. Easy to use, simply run the line through the wire loop and pull the stop onto the line. The small egg shape design permits the stop to wind onto reels and to cast easily through the rod guides.

NO. BSTPR

Packed 10 stops on a ceramic ring in a polybag on a display card, 12 cards per inner box, 1,200 per case.

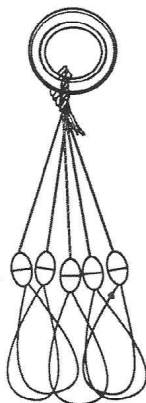

code	line test	approx. case wgt.
48	4-8 lbs.	8 lbs.
812	8-12 lbs.	11 lbs.

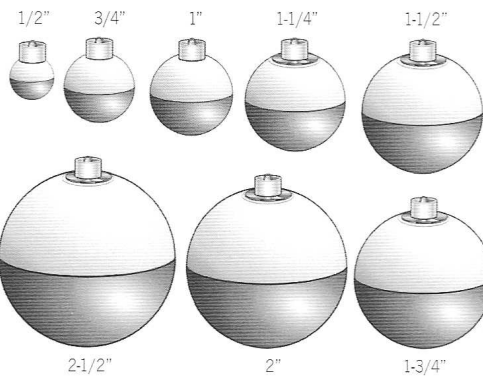

Round Snap-On Floats

These brilliantly colored snap-on floats ride better in the water and are more active when fish strike! Made of sturdy plastic to resist cracking, these floats have push button fasteners and heavy-duty springs that ensure a strong line grip.

NO. B8130SP (red & white)

NO. B8130FSP (fluorescent orange & yellow)

Packed by varied piece count per size in a polybag with header card, 12 bags per inner box, 288 per case.

code	size	pcs./ bag	approx. case wgt.
0.75	3/4"	3	9 lbs.
1.00	1"	3	13 lbs.
1.25	1-1/4"	3	18 lbs.
1.50	1-1/2"	2	17 lbs.
1.75	1-3/4"	2	24 lbs.
2.00	2"	2	29 lbs.

NO. B8130 (red & white) 12-Pack

NO. B8130F (fluor. orange & yellow) 12-Pack

Packed 12 pieces per polybag with header card, except size 2-1/2" is packed 6 each per polybag with header card.

code	size	each/ inner	each/ case	approx. case wgt.
0.50*	1/2"	144/12	1,728	8 lbs.
0.75	3/4"	144/12	1,728	13 lbs.
1.00	1"	144/12	1,728	21 lbs.
1.25	1-1/4"	144/12	1,728	31 lbs.
1.50	1-1/2"	144/12	1,728	40 lbs.
1.75	1-3/4"	72/12	864	26 lbs.
2.00	2"	72/12	864	34 lbs.
2.50	2-1/2"	48/6	576	33 lbs.

* Available in red & white only

NO. B8130BULK (red & white) 48-Pack

NO. B8130FBULK (fluor. or. & yellow) 48-Pack

Packed 12 pieces per polybag, 48 per master polybag in a carton.

code	size	each/ inner	each/ case	approx. case wgt.
0.75	3/4"	2,400/48	4,800	27 lbs.
1.00	1"	2,400/48	4,800	45 lbs.
1.25	1-1/4"	1,200/48	2,400	37 lbs.
1.50	1-1/2"	960/48	1,920	40 lbs.
1.75	1-3/4"	480/48	960	27 lbs.
2.00	2"	240/48	480	19 lbs.

Snap-On Float Assortment

Thirteen dozen assorted sizes of red and white snap-on floats are featured in a convenient shelf display box. Contains 3 dz. 1", 4 dz each 1-1/4" and 1-1/2" and 2 dz. 1-3/4" floats.

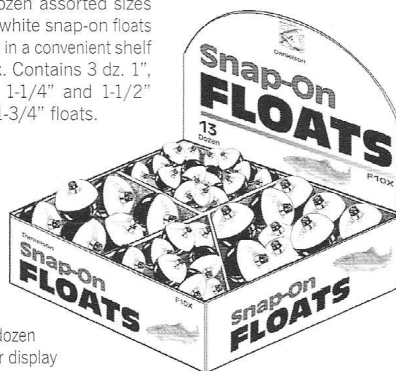

NO. F10X

Packed 13 dozen assorted per display box, 6 boxes per case. Approx. case wgt. 19 lbs.

Snap-On Float Assortment

This 10-piece snap-on float assortment contains 2 ea. 1", 3 ea. 1-1/4", 3 ea. 1-1/2" and 2 ea. 1-3/4" floats.

NO. B8130A (red & white)

NO. B8130FA (fluor. org & yel.)

Packed 10 pieces assorted per polybag with header card, 12 bags per inner box, 144 per case. Approx. case wgt. 34 lbs.

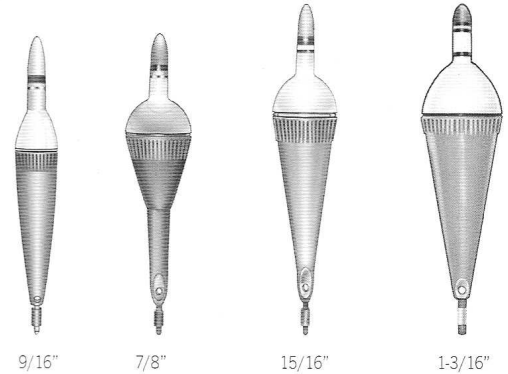
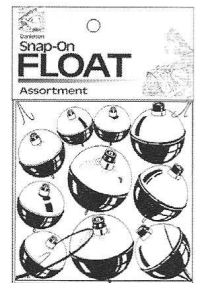

Lighted Floats

Ideal for casting or still fishing these weight-balanced, high visibility floats feature a red light for easy detection of strikes, day or night. May be fished secured to the line or as a slip float with a bobber stop for greater bait depth. The 3-volt lithium battery provides approximately 15 hours of continuous illumination.

NO. EF

Packed 1 float with battery per blister card, 12 cards per inner box, 600 per case.

code	diameter	length	approx. case wgt.
1	9/16"	4-7/16"	21 lbs.
5	7/8"	4-7/16"	26 lbs.
7	15/16"	5-1/8"	30 lbs.
11	1-3/16"	5-1/8"	35 lbs.

3V Lithium Float Batteries



Each 3-volt lithium battery keeps the light emitting diode of our item NO. EF electronic floats burning for approximately 15 hours. Simply reverse battery for daytime fishing and safe storage. Always tighten the float casing securely to keep the battery dry.

NO. EF3VB

Packed 2 batteries per blister card, 12 cards per inner box, 1,200 per case. Approx. case wgt. 21 lbs.

Rubber Practice Plugs

Indoors or outdoors, these rubber casting plugs are a great training aid for the novice and pro alike. Especially helpful when getting accustomed to the feel of a new reel or rod. Includes 1/4 oz. and 3/8 oz. sizes.

NO. PPAR

Packed 1 of each size per blister card, 12 cards per inner box, 480 per case. Approx. case wgt. 35 lbs.

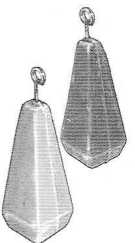

Plastic Practice Plugs

Practice makes perfect. You'll be a dead ringer with these casting plugs. Designed to improve accuracy, these plugs are great for indoor and outdoor use. Includes 1/4 oz. and 3/8 oz. sizes.

NO. PPAP

Packed 1 of each size per blister card, 12 cards per inner box, 480 per case. Approx. case wgt. 27 lbs.

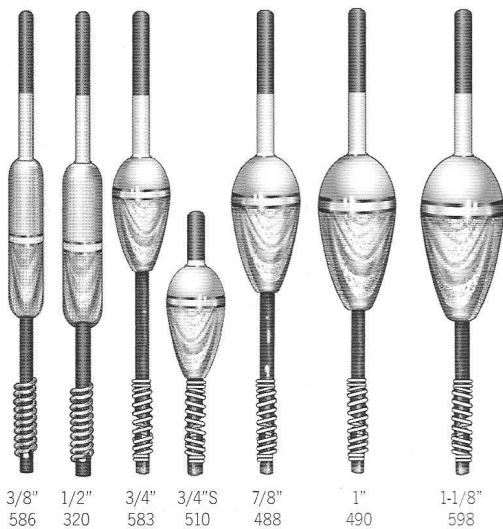

Balsa Spring Floats

The tension of the spring gently secures the line to these genuine balsa wood floats. To attach, simply compress the spring and place the line in the stem slot. Finished in fluorescent red and chartreuse with black and white striped accents the entire float is clear coated to prevent cracking and splitting.

NO. BFBSP (bulk) 12-Pack

Packed 12 each per polybag with header card, 144 each per inner box, 1,728 per case.

NO. BFSP

Packed 1 float per polybag with header card, 12 bags per inner box, 288 per case.

code	ref.	dia.	float length	stem length	shape	BFBSPP approx. case wgt.	BFSP approx. case wgt.
3/8	586	3/8"	2"	6"	pencil	21 lbs.	10 lbs.
1/2	320	1/2"	2-1/2"	6"	pencil	23 lbs.	11 lbs.
3/4	583	3/4"	1-1/2"	6"	oval	28 lbs.	12 lbs.
3/4S	510	3/4"	1-1/2"	3"	oval	18 lbs.	12 lbs.
7/8	488	7/8"	2"	6"	oval	36 lbs.	12 lbs.
1	490	1"	2-1/8"	6"	oval	45 lbs.	13 lbs.
1-1/8	598	1-1/8"	2-3/8"	6"	oval	55 lbs.	15 lbs.

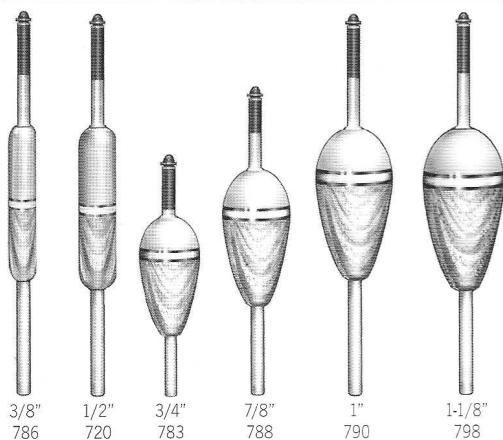

Balsa Slip Floats

Ideal for casting or still fishing these genuine balsa wood slip floats provide added casting weight and greater bait depth when used with a bobber stop. Finished in fluorescent red and chartreuse with black and white striped accents the entire float is clear coated to prevent cracking and splitting.

NO. BFBSL (bulk) 12-Pack

Packed 12 each per polybag with header card, 144 each per inner box, 1,728 per case.

NO. BFSL

Packed 1 float per polybag with header card, 12 bags per inner box, 288 per case.

code	ref.	dia.	float length	stem length	shape	BFBSL approx. case wgt.	BFSL approx. case wgt.
3/8	786	3/8"	2"	5"	pencil	13 lbs.	6 lbs.
1/2	720	1/2"	2-1/2"	5"	pencil	15 lbs.	8 lbs.
3/4	783	3/4"	1-1/2"	3"	oval	17 lbs.	9 lbs.
7/8	788	7/8"	2"	4"	oval	26 lbs.	11 lbs.
1	790	1"	2-1/8"	5"	oval	37 lbs.	12 lbs.
1-1/8	798	1-1/8"	2-3/8"	5"	oval	43 lbs.	13 lbs.

Weighted Balsa Casting Floats

Ideal for steelhead and salmon fishing these high rising balsa floats are internally weighted and balanced to cast farther. Bobber stops, peg and fluorescent beads are included. Finished in bright fluorescent color for high visibility.

code	color
CH	chartreuse
FR	fluorescent red

NO. BFWO

Packed 1 piece per blister card, 12 cards per inner box, 480 per case.

code	size	weight	approx. case wgt.
2	2"	1/2 oz.	35 lbs.
2-1/2	2-1/2"	1 oz.	51 lbs.

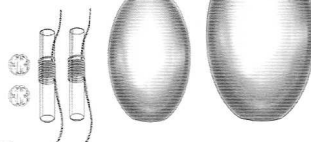

Dink Floats

Made of soft, pliable polyethylene foam these cigar-shaped floats fish parallel to the surface. Line position is easily adjusted without retying. Rig by threading line through the end-to-side plastic insert, wrap once around float and out the opposite side-to-end insert. Available in white or black with either fluorescent red or chartreuse EVA foam cap for high visibility.

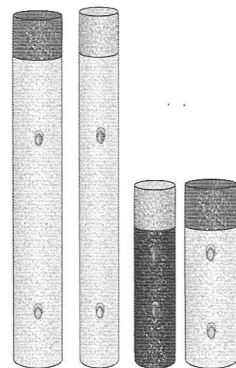

code	color
BCH	black/chartreuse
BFR	black/fluor. red
WCH	white/chartreuse
WFR	white/fluor. red

NO. DF

Packed 2 floats per polybag with header card, 12 bags per inner box, 480 per case.

code	size	approx. case wgt.
58	5/8" x 6"	14 lbs.
58S	5/8" x 3"	10 lbs.
34	3/4" x 6"	18 lbs.
34S	3/4" x 3"	13 lbs.

Slip Cast Spin Floats

Cast your favorite fly, lure, or bait with extreme accuracy with these water-weighted floats.

Made to handle every type of casting situation, they are perfect for controlling the casting distance and permitting bait rig casting as if it were a weighted lure. Easy to use, fill it with water to get desired weight and set it to the required depth with a bobber stop.

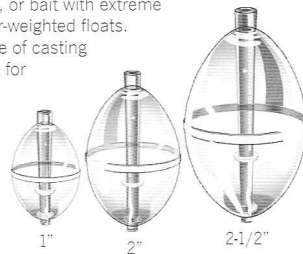

Packed 12 each per polybag with header card.

NO.	size	each/inner	each/case	approx. case wgt.
240	1"	144	1,728	16 lbs.
241	2"	144	1,728	21 lbs.
242	2-1/2"	72	864	24 lbs.

Packed by varied piece count per polybag with header card, 12 bags per inner box, 480 per case.

NO.	size	pcs./bag	approx. case wgt.
240SP	1"	2	13 lbs.
241SP	2"	2	21 lbs.
242SP	2-1/2"	1	19 lbs.

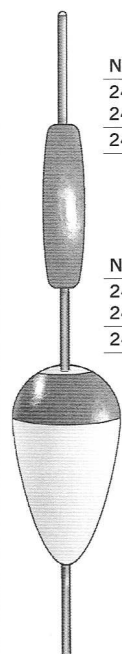

Big Water Float

Designed for rough water conditions, the big water float allows the angler to see the fluorescent red indicator at all times. It has been engineered with a weighted pear float at the bottom to keep the indicator upright and visible atop the 12" long slip tube with built-in bead at the top to accommodate a bobber stop.

NO. FBW

Packed 1 each per polybag with header card, 12 cards per inner box, 144 per case. Approx. case wgt. 20 lbs.

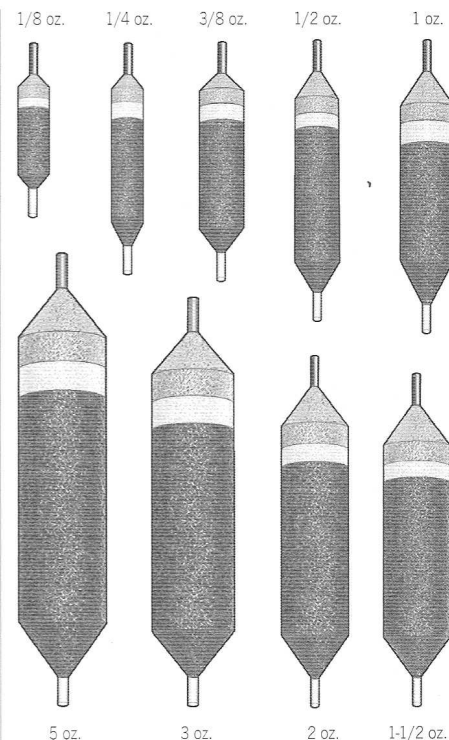

Easy Drifter Floats

Designed as in-line sliders the Easy Drifter floats are proven effective for salmon and steelhead. These floats are finished in black and highlighted in chartreuse and fluorescent red for high visibility. Two bobber stops and four fluorescent red beads included.

NO. EDF

Packed by varied piece count per full back header card, 12 cards per inner box, 144 per case.

code	drift weight	dia.	overall length	pcs./card	approx. case wgt.
1/8	1/8 oz.	9/16"	3-1/4"	2	4 lbs.
1/4	1/4 oz.	9/16"	4-1/2"	2	4 lbs.
3/8	3/8 oz.	3/4"	4-3/4"	2	5 lbs.
1/2	1/2 oz.	3/4"	5-1/2"	2	5 lbs.
1	1 oz.	1"	6"	2	6 lbs.
1-1/2	1-1/2 oz.	1-3/16"	6-3/4"	2	8 lbs.
2	2 oz.	1-3/16"	7-1/8"	1	6 lbs.
3	3 oz.	1-3/8"	8"	1	7 lbs.
5	5 oz.	1-3/8"	9"	1	8 lbs.

Spin Bubble Floats

Ideal for casting flies, poppers and ultra-light lures this spin bubble float with pull-apart housing can be filled with water for weight control. Features include spring-loaded, push button on/off line attachment.

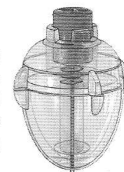

NO. FSBB

Packed 2 each per polybag with header card, 12 bags per inner box, 720 per case. Approx. case wgt. 34 lbs.

NO. FSBB (bulk) 12-Pack

Packed 12 each per polybag with header card, 144 each per inner box, 1728 per case. Approx. case wgt. 36 lbs.

Fly Casting Float

Ideal for casting flies, poppers, jigs and live bait these torpedo-shaped floats provide wind-resistant casting and enhanced action. Made of impact-resistant plastic in 1/4 oz. weight.



code	color
CL	clear
FR	fluorescent red

NO. FC14

Packed 3 pieces per blister card, 12 cards per inner box, 240 per case. Approx. case wgt. 19 lbs.

Foam Round Snap-On Floats

Made feather-light for natural presentation when casting live bait and for fixed-line fishing requiring a line weight. Durable, hard foam construction floats high and performs like cork. Features include spring-loaded, push button on/off line attachment and high visibility color.

code	color
CH	chartreuse
FR	fluorescent red
RW	red & white

NO. FFBR (bulk) 48-Pack

Packed 12 pieces per polybag, 48 per master polybag, varied number of bags in a carton.

code	size	each/ inner	each/ case	approx. case wgt.
3/4	3/4"	48	1440	6 lbs.
1	1"	48	1200	8 lbs.
1-1/4	1-1/4"	48	960	9 lbs.
1-1/2	1-1/2"	48	480	7 lbs.
1-3/4	1-3/4"	48	480	8 lbs.
2	2"	48	240	6 lbs.
3	3"	48	144	12 lbs.

NO. FFR

Packed by varied piece count per size in a polybag with header card, 12 bags per inner box, 288 per case.

code	size	pcs./ bag	approx. case wgt.
3/4	3/4"	3	7 lbs.
1	1"	3	10 lbs.
1-1/4	1-1/4"	2	10 lbs.
1-1/2	1-1/2"	2	12 lbs.
1-3/4	1-3/4"	2	15 lbs.
2	2"	2	22 lbs.
3	3"	2	48 lbs.

Weighted Foam Round Snap-On Floats

Weighted to provide accurate, long-distance casting without the need for line weights. Allows live bait to move freely. Durable, hard foam construction floats high and performs like cork. Features include spring-loaded, push button on/off line attachment and high visibility color.

code	color
CH	chartreuse
FR	fluorescent red
RW	red & white

NO. FFBRW (bulk) 48-Pack

Packed 12 pieces per polybag, 48 per master polybag, varied number of bags in a carton.

code	size	each/ inner	each/ case	approx. case wgt.
3/4	3/4"	48	1440	10 lbs.
1	1"	48	1200	14 lbs.
1-1/4	1-1/4"	48	960	22 lbs.
1-1/2	1-1/2"	48	480	17 lbs.
1-3/4	1-3/4"	48	480	23 lbs.
2	2"	48	240	19 lbs.
3	3"	48	144	39 lbs.

NO. FFRW

Packed by varied piece count per size in a polybag with header card, 12 bags per inner box.

code	size	pcs./ bag	each/ case	approx. case wgt.
3/4	3/4"	3	288	9 lbs.
1	1"	3	288	15 lbs.
1-1/4	1-1/4"	2	288	17 lbs.
1-1/2	1-1/2"	2	288	25 lbs.
1-3/4	1-3/4"	2	288	31 lbs.
2	2"	2	288	48 lbs.
3	3"	2	72	42 lbs.

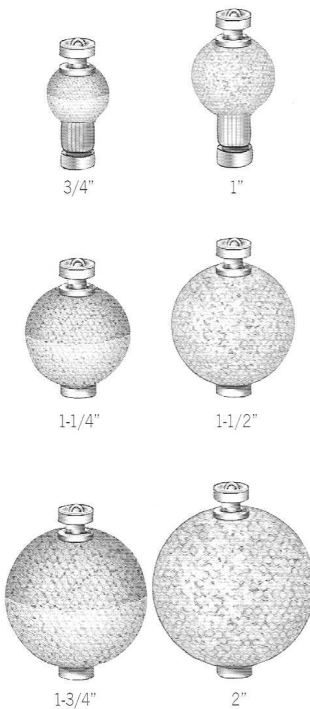
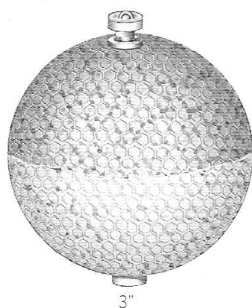
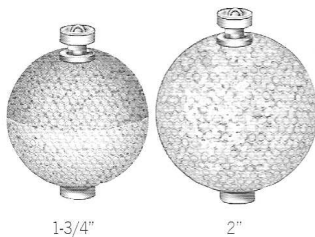
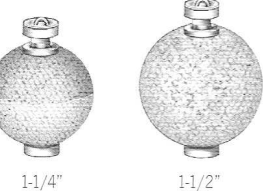
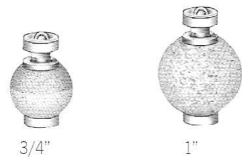

Foam Cigar Snap-On Floats

Made feather-light for natural presentation when casting live bait and for fixed-line fishing requiring a line weight. Durable, hard foam construction floats high and performs like cork. Features include spring-loaded, push button on/off line attachment and high visibility color.

code	color
CH	chartreuse
FR	fluor. red
RW	red & white

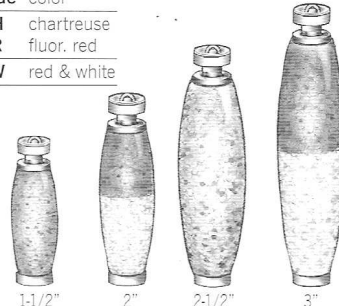

NO. FFBC (bulk) 48-Pack

Packed 12 pieces per polybag, 48 per master polybag, varied number of bags in a carton.

code	size	each/ inner	each/ case	approx. case wgt.
1-1/2	1-1/2"	48	1440	8 lbs.
2	2"	48	960	8 lbs.
2-1/2	2-1/2"	48	960	9 lbs.
3	3"	48	480	7 lbs.

NO. FFC

Packed by varied piece count per size in a polybag with header card, 12 bags per inner box, 288 per case.

code	size	pcs./ bag	approx. case wgt.
1-1/2	1-1/2"	3	8 lbs.
2	2"	3	10 lbs.
2-1/2	2-1/2"	2	11 lbs.
3	3"	2	12 lbs.

Weighted Foam Cigar Snap-On Floats

Weighted to provide accurate, long distance casting without the need for line weights. Allows live bait to move freely. Durable, hard foam construction floats high and performs like cork. Features include spring-loaded, push button on/off line attachment and high visibility color.

code	color
CH	chartreuse
FR	fluor. red
RW	red & white

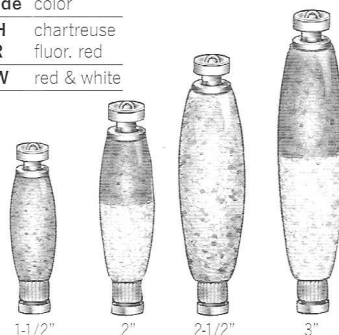

NO. FFBCW (bulk) 48-Pack

Packed 12 pieces per polybag, 48 per master polybag, varied number of bags in a carton.

code	size	each/ inner	each/ case	approx. case wgt.
1-1/2	1-1/2"	48	1440	14 lbs.
2	2"	48	960	13 lbs.
2-1/2	2-1/2"	48	960	15 lbs.
3	3"	48	480	13 lbs.

NO. FFCW

Packed by varied piece count per size in a polybag with header card, 12 bags per inner box, 288 per case.

code	size	pcs./ bag	approx. case wgt.
1-1/2	1-1/2"	3	11 lbs.
2	2"	3	14 lbs.
2-1/2	2-1/2"	2	12 lbs.
3	3"	2	19 lbs.

Foam Cigar Peg Floats

Dual-purpose peg with center hole permits slip float or fixed-line fishing. Durable, hard foam construction floats high and performs like cork. Feather-light, splash-free landings will not scare fish. Finished in high visibility color.

code	color
CH	chartreuse
FR	fluor. red
RW	red & white

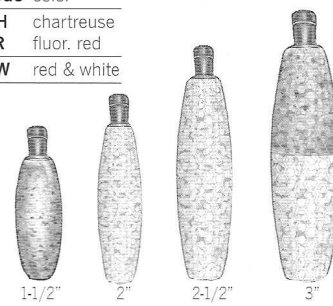

NO. FFBCP (bulk) 48-Pack

Packed 12 pieces per polybag, 48 per master polybag, varied number of bags in a carton.

code	size	each/ inner	each/ case	approx. case wgt.
1-1/2	1-1/2"	48	1440	4 lbs.
2	2"	48	960	4 lbs.
2-1/2	2-1/2"	48	960	5 lbs.
3	3"	48	480	4 lbs.

NO. FFPCP

Packed by varied piece count per size in a polybag with header card, 12 bags per inner box, 288 per case.

code	size	pcs./ bag	approx. case wgt.
1-1/2	1-1/2"	3	6 lbs.
2	2"	3	7 lbs.
2-1/2	2-1/2"	2	7 lbs.
3	3"	2	9 lbs.

Weighted Foam Oval Snap-On Floats

Weighted to provide accurate, long distance casting without the need for line weights. Allows live bait to move freely. Durable, hard foam construction floats high and performs like cork. Features include spring-loaded, push button on/off line attachment and high visibility color.

code	color
CH	chartreuse
FR	fluor. red
RW	red & white

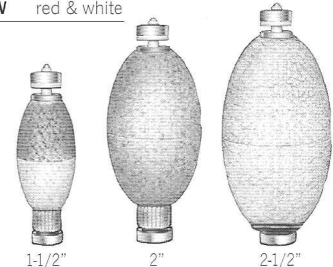

NO. FFBOW (bulk) 48-Pack

Packed 12 pieces per polybag, 48 per master polybag, varied number of bags in a carton.

code	size	each/ inner	each/ case	approx. case wgt.
1-1/2	1-1/2"	48	960	14 lbs.
2	2"	48	960	24 lbs.
2-1/2	2-1/2"	48	480	19 lbs.

NO. FFBW

Packed by varied piece count per size in a polybag with header card, 12 bags per inner box, 288 per case.

code	size	pcs./ bag	approx. case wgt.
1-1/2	1-1/2"	2	11 lbs.
2	2"	2	17 lbs.
2-1/2	2-1/2"	2	25 lbs.

Foam Cigar Spring Floats

No tying, looping or threading to attach, simply compress the spring, place the line in the slot and release. Durable, hard foam construction floats high and performs like cork. Super sensitive and finished in high visibility color.

code	color
RW	red & white

NO. FFBCSP (bulk) 48-Pack
Packed 12 pieces per polybag, 48 per master polybag, varied number of bags in a carton.

code	size	stick length	each/inner	each/case	approx. case wgt.
2	2"	5-1/2"	48	1200	13 lbs.
2-1/2	2-1/2"	5-1/2"	48	960	12 lbs.
3	3"	6-1/2"	48	480	8 lbs.

NO. FFCSP

Packed by varied piece count per size in a polybag with header card, 12 bags per inner box, 288 per case.

code	size	stick length	pcs./bag	approx. case wgt.
2	2"	5-1/2"	3	13 lbs.
2-1/2	2-1/2"	5-1/2"	2	12 lbs.
3	3"	6-1/2"	2	15 lbs.

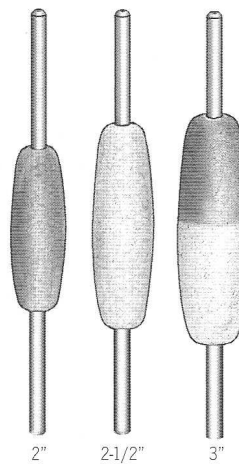

Foam Cigar Slip Stick Floats

Slip float and bobber stops permit fishing at a desired depth; yet allow casting a bait rig just like a lure. Easy-thread eyelet eliminates the need for a slip bead. Durable, hard foam construction floats high and performs like cork. Finished in high visibility color.

code	color
CH	chartreuse
FR	fluorescent red
RW	red & white

NO. FFBCS (bulk) 48-Pack
Packed 12 pieces per polybag, 48 per master polybag, varied number of bags in a carton.

code	size	stick length	each/inner	each/case	approx. case wgt.
2	2"	5"	48	1200	13 lbs.
2-1/2	2-1/2"	5"	48	960	10 lbs.
3	3"	5"	48	480	6 lbs.

NO. FFCS

Packed by varied piece count per size in a polybag with header card, 12 bags per inner box, 288 per case.

code	size	stick length	pcs./bag	approx. case wgt.
2	2"	5"	3	12 lbs.
2-1/2	2-1/2"	5"	2	10 lbs.
3	3"	5"	2	13 lbs.

Add-On Float Weights

Add weight to most slip floats; simply slide the sleeve weight and O-ring onto the lower float shaft and up against the body of the float. Choose either 1 gram or 1.5 gram weight. Also works with some spring floats.

NO. FWA0

Packed 10 weights and O-rings per full back header card, 12 cards per inner box, 240 per case. Approx. case wgt. 9 lbs.

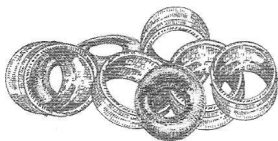

Slotted Popping Floats

Rod tip action allows the cupped top to make fish attracting popping, chugging sounds. Featured slot makes for quick on/off line attachment and easy-thread eyelet eliminates the need for a slip bead. Durable hard foam construction finished in high visibility colors.

code	color
RW	red & white

NO. FPS

Packed 1 each per polybag with stick-on label, 12 pieces per master polybag, 240 per case.

code	size	approx. case wgt.
2	2"	4 lbs.
3	3"	4 lbs.
4	4"	8 lbs.
5	5"	10 lbs.

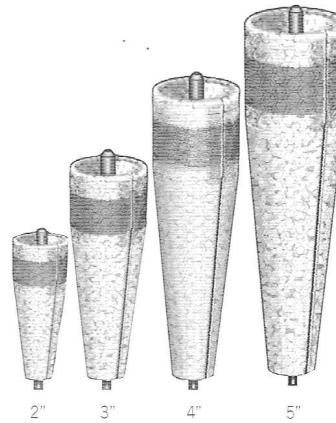

Weighted Slotted Popping Floats

Rod tip action allows the cupped top to make fish attracting popping, chugging sounds. Weighted for casting without the need for line weights. Featured slot makes for quick on/off line attachment and easy-thread eyelet eliminates the need for a slip bead. Durable hard foam construction finished in high visibility colors.

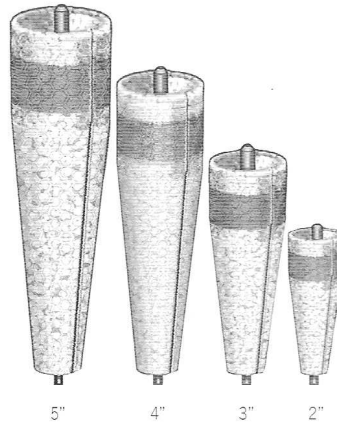

code	color
RW	red & white

NO. FPSW

Packed 1 each per polybag with stick-on label, 12 pieces per master polybag, 240 per case.

code	size	approx. case wgt.
2	2"	7 lbs.
3	3"	12 lbs.
4	4"	14 lbs.
5	5"	19 lbs.

Weighted Rigged Popping Floats

Features a wire loop for leader attachment and a swivel at the bottom to permit bait to move freely. Rod tip action allows the cupped top to make fish attracting popping, chugging sounds. Weighted for casting without the need for line weights. Durable hard foam construction finished in high visibility colors.

code	color
RW	red & white

NO. FPRW

Packed 1 each per polybag with stick-on label, 12 pieces per master polybag, 240 per case.

code	size	approx. case wgt.
2	2"	7 lbs.
3	3"	12 lbs.
4	4"	14 lbs.
5	5"	18 lbs.

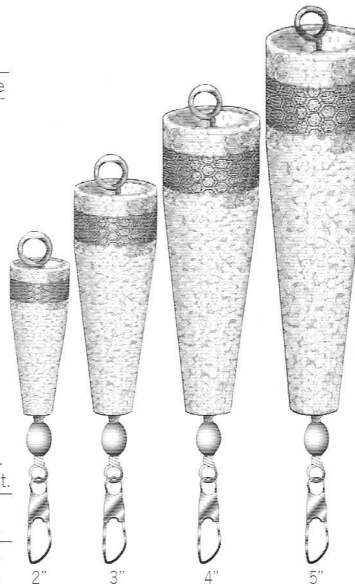

Pier Floats

Made for rough choppy water these easy-to-spot, high-rise floats are ideal for pier, surf and dam. Fish as a slip float to a desired depth or let bait go to the bottom. Durable hard foam construction performs like cork. Finished in high visibility colors.

code	color
RW	red & white

NO. FFP

Packed 1 each per polybag with stick-on label, 12 pieces per master polybag, 240 per case.

code	size	approx. case wgt.
8	8"	11 lbs.
10	10"	14 lbs.

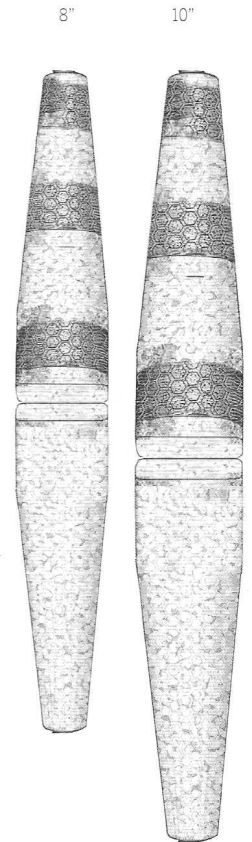

Weighted Pier Floats

Weighted for casting these easy-to-spot, high-rise floats are ideal for rough, choppy waters. Fish as a slip float to a desired depth or let bait go to the bottom. Durable hard foam construction performs like cork. Finished in high visibility colors.

code	color
RW	red & white

NO. FFPW

Packed 1 each per polybag with stick-on label, 12 pieces per master polybag, 240 per case.

code	size	approx. case wgt.
8	8"	18 lbs.
10	10"	25 lbs.

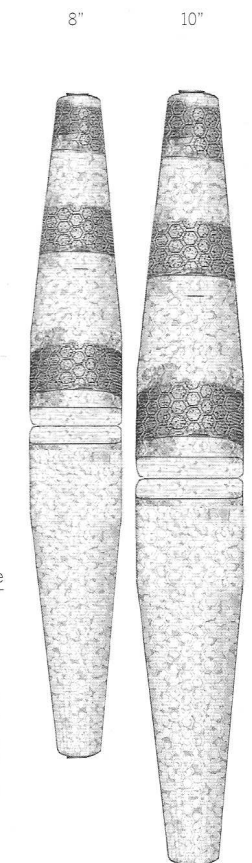

Crappie Rig

This crappie rig is constructed with two free-turning, stainless steel spreader arms that allow the bait to move. Tied with gold Aberdeen hooks, the rig features beads, barrel swivel for mainline hook-up and bottom snap for attaching weight.

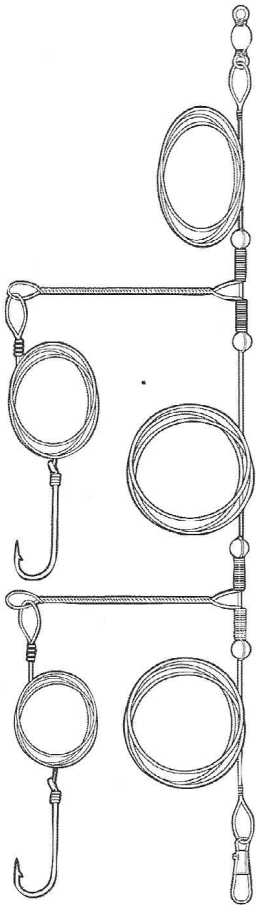

NO. 132
Packed 1 rig per polybag with insert card, 12 cards per inner box, 600 per case.

code	hook size	approx. case wgt.
8	8	13 lbs.
6	6	13 lbs.
4	4	13 lbs.
2	2	13 lbs.
1	1	13 lbs.
1/0	1/0	14 lbs.
2/0	2/0	14 lbs.

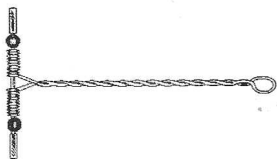

Wire Spreader Arms

These free-turning spreader arms let bait move easily and keep the hooks away from the mainline. Constructed of stainless steel wire, they are made to use with nylon monofilament and multi-strand wire leaders.

NO. RGSA

Packed 2 per polybag with insert card, 12 cards per inner box, 1,200 per case. Approx. case wgt. 16 lbs.

Floating Harness

Expertly designed, this worm harness holds night crawlers up and away from the bottom where fish can see them. An Indiana spinner adds flash and sound to brightly colored twin floats, making them extremely effective on most gamefish.

code	blade color	float color
GL	green/yellow	lime
GO	gold	orange
OY	orange/yellow	yellow
YY	yellow	yellow

NO. WHF

Packed 1 rig per polybag with insert card, 12 cards per inner box, 240 per case. Approx. case wgt. 4 lbs.

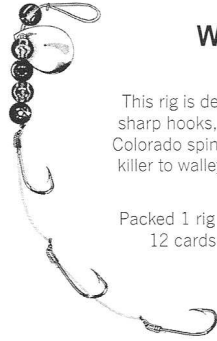

Worm Harness with Colorado Spinner

This rig is deadly! Rigged with three razor sharp hooks, red fluorescent beads and a Colorado spinner, this crawler harness is a killer to walleye, bass and other gamefish.

NO. WHC

Packed 1 rig per polybag with insert card, 12 cards per inner box, 240 per case. Approx. case wgt. 4 lbs.

Double Hook Walleye Rig

Double the trouble for walleye and other hard fighting gamefish with this deadly double hook rig. Designed specifically to be used with night crawlers, it features a colorful Indiana spinner.

code	blade color
CH	chartreuse
FO	fluor. orange
LM	lime
S	silver

NO. RWDH4 (hook size 4)
NO. RWDH2 (hook size 2)

Packed 1 rig per polybag with insert card, 12 cards per inner box, 240 per case. Approx. case wgt. 5 lbs.



Bullhead/Catfish Rig

Sharp teeth and powerful jaws are no match for the nylon-coated, stranded stainless steel leader of this bullhead rig. It features a barrel swivel for an easy mainline hook-up and both the 12" leader and single 6" drop have nickel interlock snaps.

NO. BH24

Packed 1 rig per polybag with insert card, 12 cards per inner box, 600 per case. Approx. case wgt. 14 lbs.



3-Way River Rig

Also known as the Wolf River Rig, this effective fast water rig catches bass, walleye and pike! Features include a three-way swivel, heavy test nylon monofilament, size 4 gold Aberdeen hook and a bass casting sinker.

NO. RGWR

Packed 1 rig per polybag with insert card, 12 cards per inner box, 240 per case. Approx. case wgt. 19 lbs.

Hook, Swivel and Sinker Assortment

Complete your tackle box with this 75-piece assortment. It contains baitholder and Aberdeen hooks, brass snap swivels, removable split-shot, and bass casting sinkers in a variety of sizes to cover all bases.



NO. D1007

Packed 1 assortment per dial box on a blister card, 12 cards per inner box, 144 per case. Approx. case wgt. 29 lbs.

Snap Swivel Assortment

For a quick change of lure and leader, you can choose just the right safety snap swivel from this 20-piece assortment.



It is easy to find the swivel you are looking for through the transparent lid of this five compartment dial box. Made of solid brass, they have attached sure-lock safety snaps.

NO. D1002 (brass)
NO. D1009 (black)

Packed 1 assortment per dial box on a blister card, 12 cards per inner box, 144 per case. Approx. case wgt. 15 lbs.

Sinker Assortment

Made with soft virgin lead to ensure quality and consistency, this 62-piece sinker assortment contains split-shot, bass casting, pinch-on and worm weights in a variety of sizes to meet any casting, trolling or bottom fishing situation.

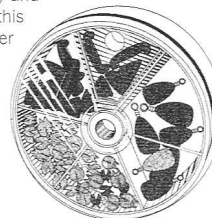

NO. D1001

Packed 1 assortment per dial box on a blister card, 12 cards per inner box, 120 per case. Approx. case wgt. 30 lbs.

Bead Assortment

Perfect for making or modifying lures and rigs, you can choose from 120 pieces of fluorescent red or chartreuse color beads in 5, 6 and 8 millimeter sizes.

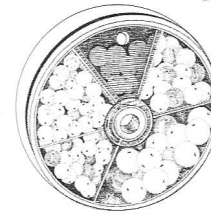

A superb buy, it is easy to select the beads you want through the see through lid of this five compartment, impact-resistant dial box.

NO. D1008

Packed 1 assortment per dial box on a blister card, 12 cards per inner box, 120 per case. Approx. case wgt. 14 lbs.

Baitholder Hook Assortment

A favorite of bait fishermen, the double sliced barbs on the back of the shank of these down-eye, offset hooks keep the bait where it belongs!



This five compartment, impact-resistant dial box has 100 bronze baitholder hooks in assorted sizes.

NO. D1003

Packed 1 assortment per dial box on a blister card, 12 cards per inner box, 144 per case. Approx. case wgt. 17 lbs.

Treble Hook Assortment

The razor sharp, hollow ground, curved points of these forged bronze treble hooks can stand up to the bite of even the mightiest gamefish!



The see-through plastic lid of the five compartment dial box lets you find the hook size you are looking for in this 20-piece set.

NO. D1005

Packed 1 assortment per dial box on a blister card, 12 cards per inner box, 144 per case. Approx. case wgt. 13 lbs.

Trout Fly Assortment

Hand-tied by skilled craftsmen, this 10-piece assortment has just the dry flies you'll need for fishing rivers and mountain lakes. Easily choose from a variety of fish catching patterns and sizes, through the transparent lid of this five compartment dial selector box.

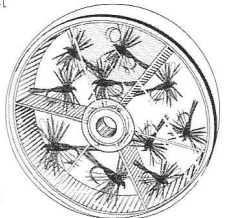

NO. D1004

Packed 1 assortment per dial box on a blister card, 12 cards per inner box, 144 per case. Approx. case wgt. 13 lbs.

Popper Assortment

There is no doubt that you can bring a lunker to the surface with this complete selection of top-water bugs. A perfect addition to any tackle box, this assortment has six brilliantly colored poppers in an easy to use, impact-resistant dial box. Offering superb value, the clear lid makes it a snap to find your selection.

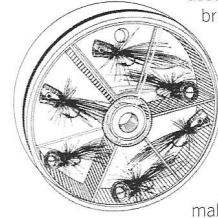

NO. D1006

Packed 1 assortment per dial box on a blister card, 12 cards per inner box, 144 per case. Approx. case wgt. 12 lbs.

Demon Spoon Assortment

The Demon spoon assortment has the perfect lures that attract a variety of gamefish. These spoons are designed to wobble, dart and attract even the most cunning fish. This set includes five spoons of varying weights, colors and patterns that address the fishing situation at hand.

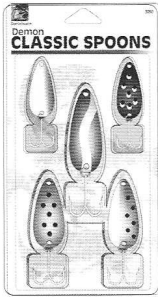

NO. 3050

Packed 5 spoons per blister card, 12 cards per inner box, 144 per case. Approx. case wgt. 18 lbs.

Demon Spoon Assortment

It's a fact that fishermen catch fish with this five spoon assortment of varying weights. The darting and wobbling action, and red and white stripe design make the Demon one of the most effective spoons for trolling and casting.

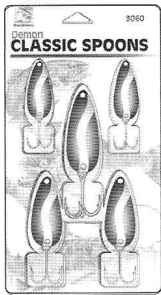

NO. 3060

Packed 5 spoons per blister card, 12 cards per inner box, 144 per case. Approx. case wgt. 18 lbs.

Trouble Maker Spoon Assortment

The unique design of this four spoon set create a powerful influence over gamefish. Designed to attract attention with their darting and wobbling action, these casting and trolling spoons catch trout, bass and more!

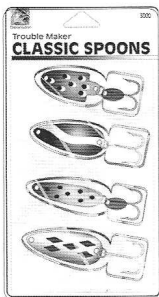

NO. 3000

Packed 4 spoons per blister card, 12 cards per inner box, 144 per case. Approx. case wgt. 15 lbs.

Magnum Demon Spoon Assortment

For big fish and big water situations, the Magnum Demon spoon assortment does the trick. Great for casting and trolling these red and white lures have an effective wobbling action to attract fish and provoke the strike. Assortment contains three spoons of varying weight.

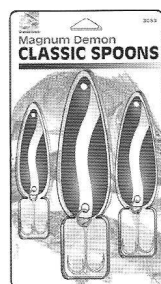

NO. 3053

Packed 3 spoons per blister card, 12 cards per inner box, 144 per case. Approx. case wgt. 25 lbs.

Dandy Spinner Assortment

A proven success, this spinner assortment has two 1/8 oz. and one 1/4 oz. French style lures. Deadly on all gamefish, these spinners feature treble hooks and blades which revolve around the lure to attract fish by sight and sound!

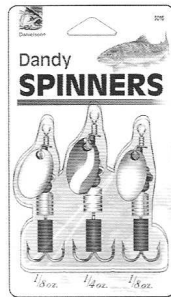

NO. 3015

Packed 3 spinners per blister card, 12 cards per inner box, 144 per case. Approx. case wgt. 9 lbs.

Bantam Tail Spinner Assortment



A terrific lure for all species of gamefish! These spinners feature extra sharp treble hooks for a good hook-set! Their free spinning blades, slender design and hackle tails make gamefish want to strike. Assortment contains three 1/8 oz. lures.

NO. 3025

Packed 3 spinners per blister card, 12 cards per inner box, 144 per case. Approx. case wgt. 12 lbs.

Marble Spinner Assortment

These treble hook Marble spinners are killers on all types of gamefish! Great for fishing in fast water or trolling, their unique spinning action and hackle tail make fish strike out of instinct. This three pack assortment contains two 1/8 oz. and one 1/4 oz. lure.



NO. 3013

Packed 3 spinners per blister card, 12 cards per inner box, 144 per case. Approx. case wgt. 12 lbs.

Mini Mite Spoon Assortment

The unique shape and wobbling action of these Mini Mite lures catch fish in a flash! Irresistible to small gamefish, this assortment has six brilliantly painted spoons in the most popular patterns and colors.

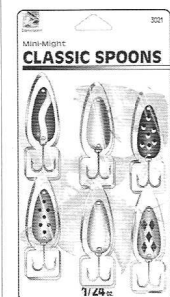

NO. 3021 (1/24 oz.)

NO. 3022 (1/8 oz.)

Packed 6 spoons per blister card, 12 cards per inner box, 144 per case. Approx. case wgt. 15 lbs.

Grub Kit

The enticing, undulating motion of these grubs is proven deadly to panfish and gamefish of all types. The spiral ribbing creates sonic turbulence and traps air to be released as bubbles. This 57-piece kit includes grubs, split-tails, jig heads and jig spinners in an assortment of sizes and colors.

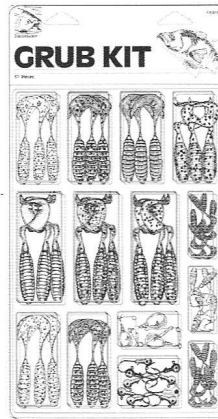

NO. CK200

Packed 1 kit per clam-pack with header card, 12 per inner box, 144 per case. Approx. case wgt. 51 lbs.

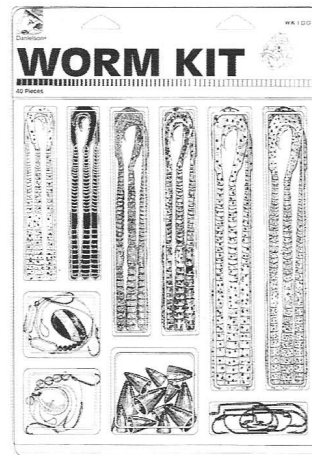

Worm Kit

With the look and feel of the real thing these worms provide the squirming action that gamefish can't resist. The soft textured body will have fish striking harder and holding on longer. This 40-piece kit includes worms, harnesses, hooks and worm weights in an assortment of sizes and colors.

NO. WK100

Packed 1 kit per clam-pack with header card, 12 per inner box, 60 per case. Approx. case wgt. 32 lbs.

Jig Kit

Lively action and undulating motion make these jigs deadly on panfish and gamefish alike.

This 16-piece kit includes crappie jigs, mini jigs, grub jigs, spin grub jigs and spin split-tail jigs in an assortment of sizes and colors.

NO. JK100

Packed 1 kit per clam-pack with header card, 12 per inner box, 144 per case. Approx. case wgt. 34 lbs.

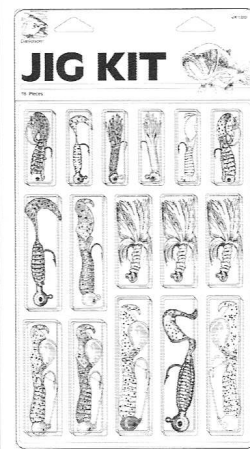

Trout Kit

Everything you need to fill that stringer is provided in this 68-piece trout kit. Selection includes spoons, spinners, flies, hooks, swivels and sinkers in an assortment of types, sizes, colors and patterns.

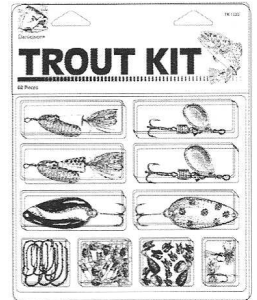

NO. TK100

Packed 1 kit per clam-pack with header card, 12 per inner box, 144 per case. Approx. case wgt. 35 lbs.



Panfish Kit

Even the most finicky panfish can't resist the lures in this 72-piece kit. Selection includes crappie jigs, mini jigs, grub jigs, spin grub jigs, crappie rigs, hooks, swivels and sinkers in an assortment of types, sizes and colors.

NO. PK100

Packed 1 kit per clam-pack with header card, 12 per inner box, 144 per case. Approx. case wgt. 37 lbs.

Gamefish Kit

Be prepared with this selection of proven lures for trout, bass, walleye and other gamefish. This 12-piece kit includes spoons, spinners, grub jigs, spin grub jig, spin split-tail jig and shad in an assortment of types, sizes, colors and patterns.

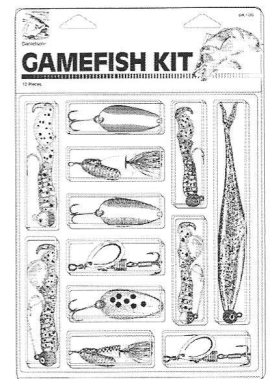

NO. GK100

Packed 1 kit per clam-pack with header card, 12 per inner box, 144 per case. Approx. case wgt. 39 lbs.

Bass Kit

With the look and feel of the real thing these soft bait lures provide the undulating action that bass can't resist. This 19-piece

kit includes worms, grub jigs, split-tail jigs, spin grub jigs, shad, worm harness and worm weights in an assortment of sizes and colors.

NO. BK100

Packed 1 kit per clam-pack with header card, 12 per inner box, 144 per case. Approx. case wgt. 54 lbs.

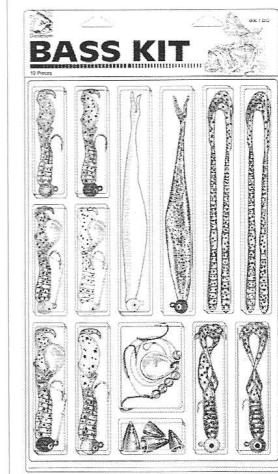

Dry Flies

These durable hand tied dry flies are realistic imitations of attractive food sources for trout. Usually fished with a conventional dead drift or by skittering them across the water's surface.

NO. FD

Packed 2 per blister card, 12 cards per inner box, 480 per case. Approx. case wgt. 11 lbs.

code	description	size code
111	Adams	12 14
112	Adams Female	12 14
113	Black Ant	12 14
131	Dark Caddis Bucktail	12 14
133	Elk Hair Caddis	12 14
136	Light Cahill	12 14
138	Coachman	12 14
139	Royal Coachman	10 12 14
171	Black Gnat	12 14
182	Grey Hackle Peacock	12 14
183	Grey Hackle Yellow	12 14
186	Joe's Hopper	8 10
187	Red Humpy	12 14
196	Irresistible	12
231	Brown Mayfly	12 14
234	White Miller	12 14
236	Mosquito	12 14 16
281	Renegade	12 14
331	Royal Wulff	12 14

Nymphs

The main course year round for trout is nymphs, and you can catch more trout by working the bottom of the stream or river with these superb, hand tied imitations. Usually fished upstream by letting the nymph sink and then drift along the bottom.

NO. FN

Packed 2 per blister card, 12 cards per inner box, 480 per case. Approx. case wgt. 11 lbs.

code	description	size code
431	Caddis Standard	12
481	Gold Ribbed Hare's Ear	12
482	Hellgrammite	8 10 12
541	Black Nymph	10 12
562	Pheasant Tail	10 12
591	Black Stonefly	8 10 12
592	Brown Stonefly	10 12
661	Zug Bug	12

Wet Flies

Ideal for lakes and streams, these hand tied wet flies and woolly worms are effective from the bottom to the surface. Usually fished with a dead drift or with short strips on the retrieve.

NO. FW

Packed 2 per blister card, 12 cards per inner box, 480 cards per case. Approx. case wgt. 11 lbs.

code	description	size code
731	Green Carey Special	10
733	Red Carey Special	10
971	Black Woolly Worm	8 10
972	Brown Woolly Worm	8 10
975	Olive Woolly Worm	8 10
979	Yellow Woolly Worm	8 10

Streamers

Streamers are the answer when the fish aren't biting at the surface and they perform in almost every type of fishing situation! Intended to imitate a baitfish, they are proven to be some of the most effective fly patterns ever made.

NO. FS

Packed 2 per blister card, 12 cards per inner box, 480 per case. Approx. case wgt. 11 lbs.

code	description	size code
831	Black Marabou	8 10
837	Muddler Minnow	6 8 10

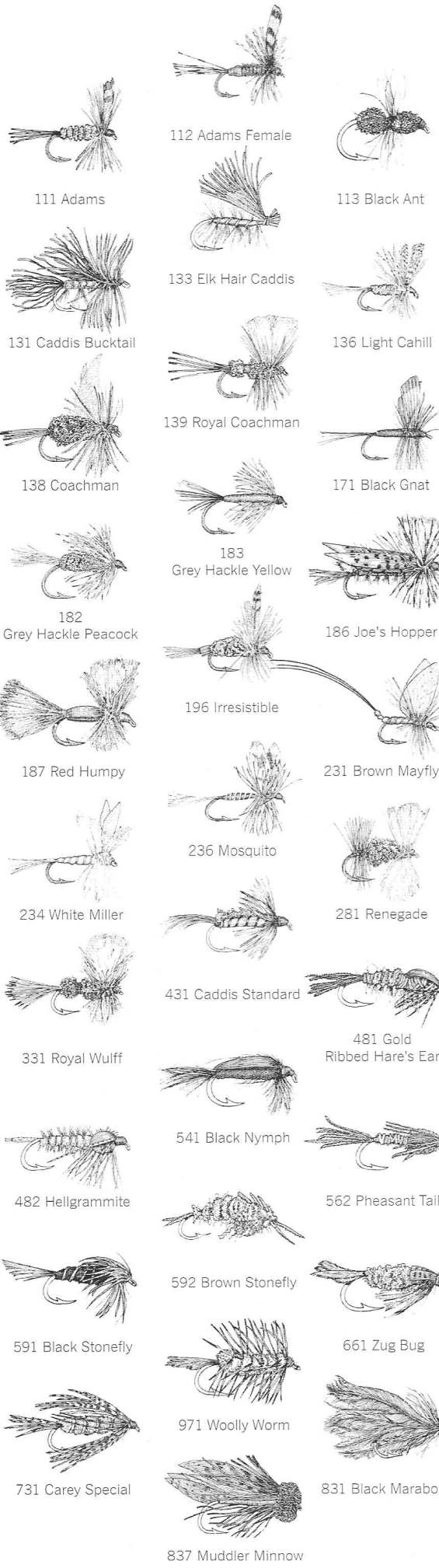

Fly & Bug Poppers

Imitating a variety of natural flies and bugs, these hand tied, poppers attract panfish by producing surface disturbance and noise. Straight tapered body is hackle dressed and features a flat face and brightly colored lacquer finish with painted eyes. Durable, hard foam construction floats high and performs like cork.

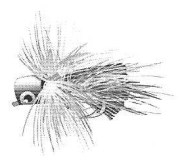

code	color
BLK	black
CH	chartreuse
GRN	green
RED	red
WHT	white
YEL	yellow

NO. PRFB

Packed 2 per blister card, 12 cards per inner box, 480 per case. Approx. case wgt. 11 lbs.

code	size
10	10

Wiggle Leg Poppers

Dressed with hackle and rubber wiggle legs these hand tied poppers imitate a variety of bugs and insects and attract panfish by producing surface disturbance and noise. A tapered body features a flat face and brightly colored lacquer finish with painted eyes. Durable, hard foam construction floats high and performs like cork.

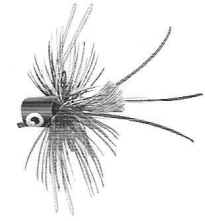

code	color
BLK	black
CH	chartreuse
FRG	frog
WHT	white

NO. PRWL

Packed 2 per blister card, 12 cards per inner box, 480 per case. Approx. case wgt. 12 lbs.

code	size
10	10
8	8

Popper Assortment

Poppers are a proven producer for all species of panfish and bass. The assortment includes tapered body, flat-faced designed wiggle leg and fly & bug poppers each in four fishenticing color patterns.

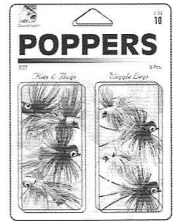

NO. 3027

Packed 8 pieces per blister card, 12 cards per inner box, 144 per case. Approx. case wgt. 6 lbs.

Trout Fly Assortment

Fine quality materials and superb workmanship are brought together to produce these great dry flies. Available in an assortment of popular patterns, they are tied to exact specifications on premium quality, razor sharp hooks.



NO. J14

Packed 12 flies per blister card, 12 cards per inner box, 288 per case.

code	size	approx. case wgt.
10	10	13 lbs.
12	12	13 lbs.
14	14	13 lbs.

Trout Fly Assortment

This dry fly assortment offers a variety of the most popular patterns. These flies are hand tied by skilled craftsmen to exact specifications. Using only top quality materials and premium grade hooks, each fly is individually packaged in its own bubble on a display card.

NO. 3004

Packed 12 flies per blister card, 12 cards per inner box, 144 per case.

code	size	approx. case wgt.
10	10	8 lbs.
12	12	8 lbs.

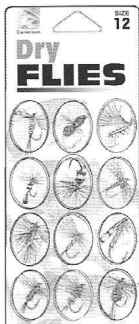

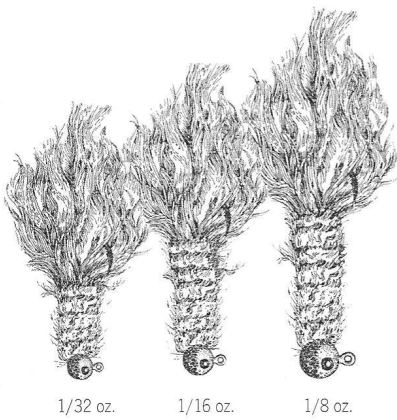

Crappie Jigs

Proven effective on crappie, bluegill, bass, perch and trout, the crappie jig's incredible reputation and fish catching abilities make it a favorite among fishermen. This dynamic jig features a marabou tail, chenille body, gold hook and an epoxy coated head.

code	color
BBB	black
CCC	chartreuse
PNK	pink
PWW	pink/white
RWW	red/white
RYY	red/yellow
WWW	white
YYY	yellow

NO. JGC

Packed 3 per polybag with full back header card, 12 cards per inner box, 480 per case.

code	weight	hook size	approx. case wgt.
132	1/32 oz.	6	9 lbs.
116	1/16 oz.	4	12 lbs.
18	1/8 oz.	2	18 lbs.

Mini Jigs

The mini jig's undulating tentacle tail darts through the water with a motion that even the most finicky panfish can't resist. This 1/32 oz. soft body lure comes with a size 6 gold hook and is available in 22 colors.

code	color
BC	black/chartreuse
BCLS	blue/clear/silver flake
BGIL	bluegill
C	chartreuse
CHP	chartreuse pepper
CLP	clear pepper
COTC	cotton candy
GW	green/white
HPW	hot pink/white
LMCH	lime/chartreuse
MORF	motor oil/red flake
NG	luminous pearl
ORCH	orange/chartreuse
PLRB	plum/red & blue flake
PMP	pumpkin pepper
RCH	red/chartreuse
RW	red/white
SMP	smoke pepper
W	white
WTML	watermelon seed
Y	yellow
YW	yellow/white

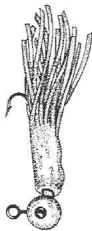

NO. JGM

Packed 3 per polybag with full back header card, 12 cards per inner box, 240 per case. Approx. case wgt. 6 lbs.

Natural Scent Grubs

The enticing, undulating motion of these natural scent grubs is proven deadly to panfish and gamefish of all types. The spiral ribbing create a sonic turbulence and traps air to be released as bubbles as the grub sinks. Once fish bite into the life-like soft textured body they'll fight to hang on.

code	color
BGIL	bluegill
BPP	blue pearl pepper
CHP	chartreuse pepper
CLP	clear pepper
COP	cocoa pepper
COTC	cotton candy
PMP	pumpkin pepper
PMPG	pumpkin pepper/green flake
SMP	smoke pepper
WHT	white
WTML	watermelon seed

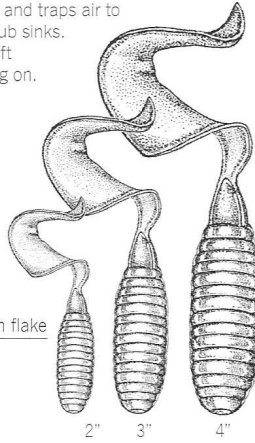

NO. SBG

Packed by varied piece count per size in a resealable zip-lock bag, 12 bags per inner box, 240 per case.

code	length	pcs./bag	approx. case wgt.
2	2"	14	12 lbs.
3	3"	12	16 lbs.
4	4"	10	24 lbs.

Natural Scent Split-Tail Grub

A terrific trailer for spinner baits and jigs these split-tail grubs provide lively action and undulating motion at the slightest movement. The soft textured body feels like the real thing when fish grab on and the natural scent keeps them fighting to hold on.

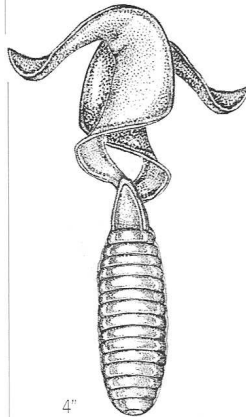

code	color
BGIL	bluegill
BPP	blue pearl pepper
CHP	chartreuse pepper
CLP	clear pepper
COP	cocoa pepper
COTC	cotton candy
PMP	pumpkin pepper
PMPG	pumpkin pepper/grn. flake
SMP	smoke pepper
WHT	white
WTML	watermelon seed

NO. SBGS4

Packed 10 grubs in a resealable zip-lock bag, 12 bags per inner box, 240 per case. Approx. case wgt. 23 lbs.

Dart Jigs

This dart jig has been catching gamefish for a long time. No wonder, its unique slant nose, two-toned epoxy coated head and bucktail streamer entice even the most finicky lunger.

code	head/body & tail
RC	red/chartreuse
RW	red/white
RY	red/yellow

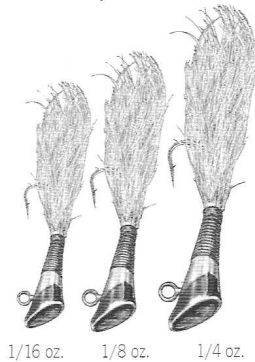

NO. DJ

Packed 2 jigs per blister card, 12 cards per inner box, 864 per case.

code	jig weight	hook size	approx. case wgt.
16C	1/16 oz.	6	23 lbs.
18C	1/8 oz.	4	28 lbs.
14C	1/4 oz.	4	37 lbs.

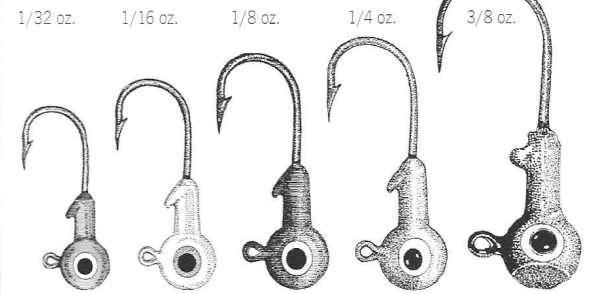

Painted Lead Jig Heads

Made for use with soft plastic baits, these lead jig heads feature a double-eye design and chip-resistant epoxy finish in a wide selection of fish attracting colors. Made with bronze Aberdeen hooks and equipped with bait holding barbs.

code	color
B	black
CH	chartreuse
CHB	chartreuse/black
CHLM	chartreuse/lime
CHOR	chartreuse/fluorescent orange
FO	fluorescent orange
FP	fluorescent pink
FR	fluorescent red
FT	fire tiger
GL	luminous
R	red
W	white

NO. JH

Packed by varied piece count per size in a clam-pack, 12 packs per inner box.

code	weight	hook size	pcs./pack	packs/case	approx. case wgt.
132	1/32 oz.	6	10	240	12 lbs.
116	1/16 oz.	4	10	240	19 lbs.
18	1/8 oz.	2	8	240	22 lbs.
14	1/4 oz.	1/0	7	120	18 lbs.
38	3/8 oz.	2/0	6	120	21 lbs.

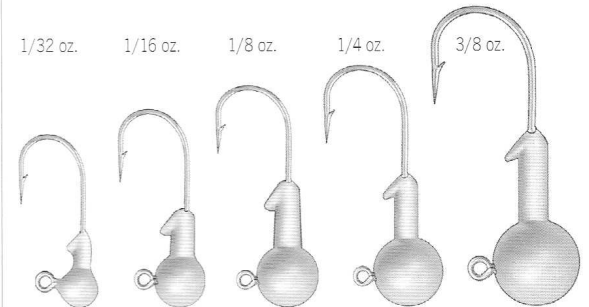

Lead Jig Heads

These non-painted lead jig heads are just the right answer for all types of artificial bait. They feature a round head design and a bait retaining collar.

NO. JHU

Packed by varied piece count per size in a clam-pack, 12 packs per inner box.

code	weight	hook size	pcs./pack	packs/case	approx. case wgt.
132	1/32 oz.	6	25	240	21 lbs.
116	1/16 oz.	4	20	240	33 lbs.
18	1/8 oz.	2	17	240	37 lbs.
14	1/4 oz.	1/0	13	120	32 lbs.
38	3/8 oz.	2/0	10	120	33 lbs.

Jig Eye Tool

This easy to use tool quickly removes paint and coating material from the eye of the hook. With tweezer-like action, it punches through excess material. Then with a twist, the tapered sides of the punch clean the inside of the eye. Features include a vinyl coating for a sure grip and a hole for attaching a lanyard.

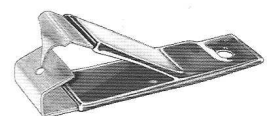

NO. JEC

Packed 1 per blister card, 12 cards per inner box, 240 per case. Approx. case wgt. 10 lbs.

Zing Tail® Spinner

Deadly for all gamefish, the Zing Tail®'s flash and vibration are enhanced by the pulsating swimming motion of its hackle tail. Available in several bait-imitating patterns and colors it is the perfect choice for casting, trolling and drift fishing.

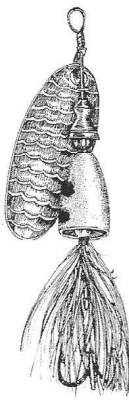

code	color/finish
BLK	black scale (N)
CF	crawfish (B)
CH	chartr. scale (B)
FR	fluor. red scale (N)
FRG	frog (B)
FT	fire tiger (B)
GH	grasshopper (B)
RT	rainbow trout (N)
RW	red/white (N)
SF	salmon fly (B)
WHT	white scale (N)
YEL	yellow scale (N)

NO. SXZ

Packed 1 each per blister card, 12 cards per inner box, 480 per case.

code	lure weight	hook size	blade size	approx. case wt.
116	1/16 oz.	12	1	12 lbs.
18	1/8 oz.	10	2	14 lbs.
316	3/16 oz.	8	3	16 lbs.
14	1/4 oz.	6	4	23 lbs.

Renegade Spoon

The Renegade is a truly remarkable, all purpose spoon for casting, trolling and jigging, its unique shape, perfect balance and jewel-like finish create a shimmering, fluttering action that fish can't resist. The special body design allows for a greater casting distance and prevents line from twisting while trolling or retrieving.

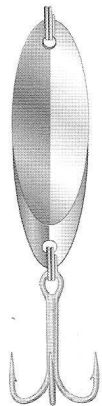

code	color/finish
FT	fire tiger (B)
G	gold
N	nickel
NCH	nickel/chartreuse
NFR	nickel/fluor. red
NNB	nickel/neon blue
RT	rainbow trout (N)

NO. SXR

Packed 1 each per blister card, 12 cards per inner box, 480 per case.

code	lure weight	hook size	spoon length	approx. case wt.
112	1/12 oz.	12	1"	13 lbs.
18	1/8 oz.	10	1-1/4"	15 lbs.
14	1/4 oz.	8	1-3/4"	18 lbs.
38	3/8 oz.	6	1-7/8"	21 lbs.
12	1/2 oz.	4	2"	24 lbs.

Dandy Mite Spoon

Ideal for trout, steelhead and salmon the wobble action of these thin-blade trolling spoons evokes a fish's predatory instincts. Rigged with a single siwash hook they feature durable, corrosion-resistant finishes.



code	color/finish
50/50 B	1/2 nickel - 1/2 brass
CHPRL FRPRL	chartreuse/pearl belly fluor. red/pearl belly
GRNPRL N	green/pearl belly nickel
PNKPRL BFR-H	hot pink/pearl belly brass/fluor. red head
NCH-H NFR-H	nickel/chartreuse head nickel/fluor. red head
NGRN-H NPNK-H	nickel/green head nickel/hot pink head
PRLFR-H PRLPNK-H	pearl/fluor. red head pearl/hot pink head

NO. SXDM

Packed 1 each per blister card, 12 cards per inner box, 480 per case.

code	size	hook size	spoon length	approx. case wt.
0	0	6	3/4"	7 lbs.
1	1	4	1"	8 lbs.
2	2	2	1-1/4"	9 lbs.

Double Dare Spoon

The unique action of the thick, little Double Dare spoon triggers the predatory nature of gamefish and provokes the strike. Its erratic action closely imitates that of a darting and diving baitfish. An excellent spoon for casting, trolling and jigging, it is ideal for deep, shallow, fast or still water.

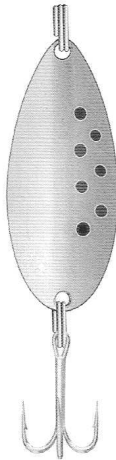

code	color/finish
FT	fire tiger (B)
G	gold
N	nickel
NCH	nickel/chartreuse
NFR	nickel/fluor. red
NNB	nickel/neon blue
RT	rainbow trout (N)

NO. SXDD

Packed 1 each per blister card, 12 cards per inner box, 480 per case.

code	lure weight	hook size	spoon length	approx. case wt.
14	1/4 oz.	6	1-5/8"	18 lbs.
25	2/5 oz.	4	2-1/16"	22 lbs.

StreamLure Spoon

A favorite of Northwest steelheaders, the StreamLure is a well balanced, 1/2 oz. or 3/4 oz. casting spoon that is sure to nail big fish. Its unique wobbling action makes it a great drift lure for steelhead, salmon, trout and even bass. Includes both treble and siwash hooks.

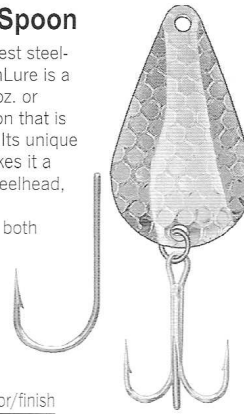

code	color/finish
CHL	chartreuse/lime stripe (N)
CHO	chartreuse/fluor. org. stripe (N)
CLWN GP	chartreuse - red spots (N) gold prism
HB	brass (ham)
HFBS	fluor. red/brass stripe (ham)
HFNS	fluor. red/nickel stripe (ham)
HN	nickel (ham)
HNB	neon blue/nickel stripe (ham)
HNG	neon grn./nickel stripe (ham)
HP	hot pink
HPP	hot pink/pearl
OBS	fluor. org. - black spots (N)
RT	rainbow trout
RWB	red/white stripe (B)
RWN	red/white stripe (N)
SH	silver haze
SP	silver prism

Packed 1 each per blister card, 12 cards per inner box, 240 per case.

code	lure weight	hook size	hook size	spoon length	approx. case wt.
12	1/2 oz.	2	1/0	1-3/4"	12 lbs.
34	3/4 oz.	1/0	2/0	2-3/8"	17 lbs.

Hypocrite Spoon

The Hypocrite is the perfect solution for hard to catch fish in a casting or trolling situation. Its unique wiggling and wobbling action and flash of colors make it irresistible to gamefish. Walleye, bass, trout, pike and muskie have all fallen victim to this incredible spoon.

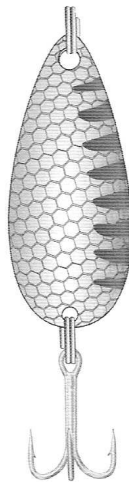

code	color/finish
B	brass
CHL	chartr./lime stripe (N)
CHO	chartr./org. stripe (N)
CRS	chartr.-red spots (N)
FRG	frog (N)
FT	fire tiger (B)
MAK	mackerel (N)
N	nickel
OBS	fluor. org.-blk. spots (N)
PER	perch (C)
RT	rainbow trout (N)
RWB	red/white stripe (B)
RWN	red/white stripe (N)
YRD	yel.-red diamonds (B)

NO. SXH

Packed 1 each per blister card, 12 cards per inner box, 240 per case.

code	lure weight	hook size	spoon length	approx. case wt.
316	3/16 oz.	8	1-3/8"	8 lbs.
14	1/4 oz.	6	1-3/4"	10 lbs.
38	3/8 oz.	6	2"	12 lbs.
12	1/2 oz.	4	2-3/16"	14 lbs.
34	3/4 oz.	2	2-7/8"	24 lbs.

Bedevile Spoon

The Bedevile is an excellent lure for just about any gamefish that feeds on baitfish. Great for casting, trolling and jigging, this lure is made of solid brass to assure consistency in weight and action. Its hammered nickel finish has light reflecting qualities that attract and provoke strikes.

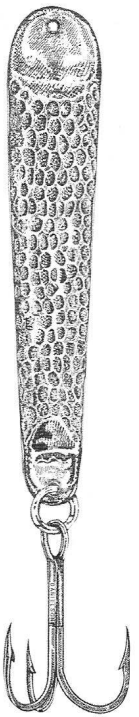

NO. SXB

Packed 1 each per blister card, 12 cards per inner box.

code	lure weight	hook size	spoon length	cards/ case	approx. case wt.
1/4	1/4 oz.	6	1-3/8"	240	10 lbs.
3/8	3/8 oz.	4	1-3/4"	240	11 lbs.
1/2	1/2 oz.	4	2-1/8"	240	13 lbs.
3/4	3/4 oz.	2	2-1/2"	240	16 lbs.
1	1 oz.	2	2-3/4"	120	10 lbs.
2	2 oz.	2/0	3-3/4"	120	21 lbs.
2 1/2	2-1/2 oz.	2/0	4-1/4"	120	24 lbs.

Jeopardizer Lure

The Jeopardizer is a fantastic lure for all types of salt and freshwater gamefish. Its multi-faceted, diamond shape design and polished nickel finish give the Jeopardizer a unique flashing action. Ideal for casting, trolling and jigging situations, this lure gets fish when other lures fail.

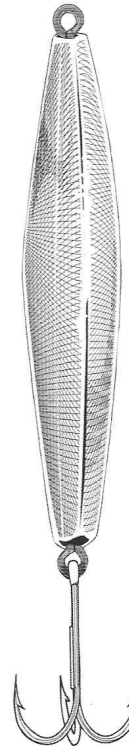

NO. JXJ (polished nickel)
Packed 1 each per blister sleeve card, 12 cards per inner box.

code	lure weight	hook size	spoon length	cards/ case	approx. case wt.
1	1 oz.	1	2-3/8"	120	12 lbs.
1 5/8	1-5/8 oz.	1/0	2-3/4"	120	17 lbs.
2	2 oz.	1/0	3-1/8"	120	21 lbs.
3	3 oz.	1/0	3-1/2"	120	29 lbs.
4	4 oz.	2/0	3-7/8"	120	36 lbs.
6	6 oz.	3/0	4-1/2"	60	28 lbs.
8	8 oz.	4/0	5"	60	34 lbs.
10	10 oz.	5/0	5-7/8"	48	36 lbs.
14	14 oz.	7/0	6-1/8"	36	36 lbs.
16	16 oz.	7/0	6-3/8"	36	41 lbs.

Easy Drifters

Proven successful for walleye, steelhead, salmon and trout Easy Drifters add color and flotation to any drift rig. These superbly buoyant drift bobbers are available in a variety of sizes and color patterns to meet nearly any water or light condition.



size 12
8mm-5/16"



size 10
10mm-3/8"



size 8
12mm-1/2"



size 6
16mm-5/8"

code	color pattern
BLKSCL	black scale
CLWN	clown
CRL	coral
EOSCL	egg orange scale
FLM	flame (FO gloss)
FLMCH	flame chartreuse
FO	fluorescent orange (flat)
FR	fluorescent red (flat)
FRBSCL	rocket red black scale
FRR	rocket red (FR gloss)
FT	fire tiger
GL	luminous
GLPCH	luminous peach
GLPS	luminous pink spot
GLR	luminous red
GRNSCL	light green scale
GTFRR	glitter rocket red
GTFT	glitter fire tiger
GTPCHS	glitter pink chart spot
GTPNK	glitter pink
GTPRLP	glitter pearl pink
LMCH	lime chartreuse
PNK	pink
PRFLM	pearl flame
PRLPCH	pearl peach
PRLPNK	pearl pink
PRLPUR	pearl purple
RT	rainbow trout
SNST	sunset
SRBT	sherbet

NO. DBP

Packed 10 per resealable clam-pack with insert card, 12 packs per inner box, 576 per case.

code	size dia.	approx. dia.	approx. case wgt.
12	8mm	5/16"	5 lbs.
10	10mm	3/8"	5 lbs.
8	12mm	1/2"	6 lbs.
6	16mm	5/8"	15 lbs.

100-Pack

NO. DB

Packed 100 each per sealed polybag with stick-on label, 50 bags per case.

code	size dia.	approx. dia.	approx. case wgt.
12	8mm	5/16"	2 lbs.
10	10mm	3/8"	2 lbs.
8	12mm	1/2"	4 lbs.
6	16mm	5/8"	5 lbs.

Spin Drifters

Proven successful for walleye, steelhead, salmon and trout the molded winged form of these Spin Drifters create vibrations that are sure to attract any fish. These superbly buoyant spinning drift bobbers are available in a variety of sizes and color patterns to meet nearly any water or light conditions.

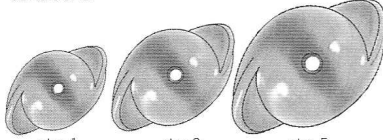

size 1
10mm-3/8"

size 3
12mm-1/2"

size 5
16mm-5/8"

code	color pattern
CLWN	clown
CRL	coral
EOSCL	egg orange scale
FLM	flame (FO gloss)
FLMCH	flame chartreuse
FRR	rocket red
FT	fire tiger
GL	luminous
GLPCH	lum. peach
GLR	luminous red
LMCH	lime chartreuse
PNK	pink
PRLPCH	pearl peach
PRLPNK	pearl pink
SNST	sunset
SRBT	sherbet

NO. SDP

Packed by varied piece count per resealable clam-pack with insert card, 12 packs per inner box, 576 per case.

code	dia.	approx. dia.	pcs./pack	approx. case wgt.
1	10mm	3/8"	8	18 lbs.
3	12mm	1/2"	7	20 lbs.
5	16mm	5/8"	8	22 lbs.

100-Pack

NO. SD

Packed 100 each per sealed polybag with stick-on label, 50 bags per case.

code	dia.	approx. dia.	approx. case wgt.
1	10mm	3/8"	7 lbs.
3	12mm	1/2"	8 lbs.
5	16mm	5/8"	9 lbs.

Trolling Spreaders

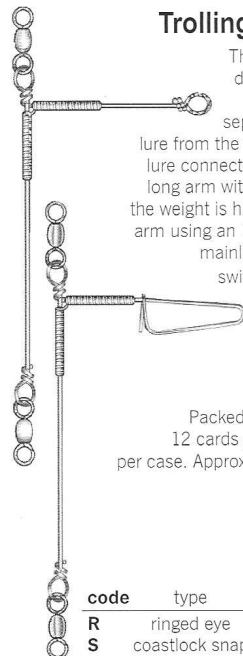

These spreaders are designed to prevent trolling tangles by separating the rigged lure from the weight. The rigged lure connects to the spreader's long arm with a 3' to 4' leader; the weight is hung from the short arm using an 18" leader and the mainline attaches to the swivel at the juncture.

NO. TS3

Packed 2 per blister card, 12 cards per inner box, 288 per case. Approx. case wgt. 14 lbs.

code	type	long arm	short arm
R	ringed eye	3-1/4"	1-3/4"
S	coastlock snap	3-1/4"	1-3/4"

Dodgers

Dodgers are designed to attract all species of gamefish with the flash and sound created by their snappy, side-to-side swaying action. Once attracted, fish strike at the erratic, darting lure or bait that is being trolled behind. Flies, squid bait, plugs, and spoons all work with dodgers.

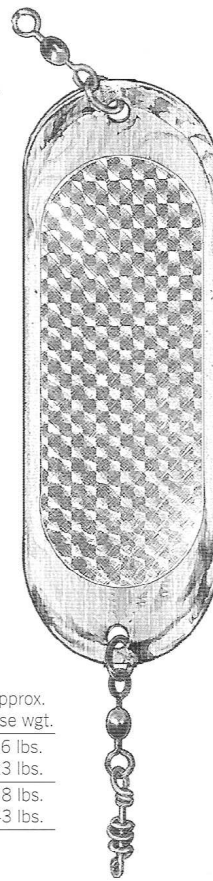

code	color
CHR	chrome
SCL	silver scale

NO. DD

Packed 1 each per blister card, 12 cards per inner box, 144 per case.

code	size	length	approx. case wgt.
000	000	4-1/2"	16 lbs.
00	00	6"	23 lbs.
0	0	8"	38 lbs.
1	1	8-3/4"	43 lbs.

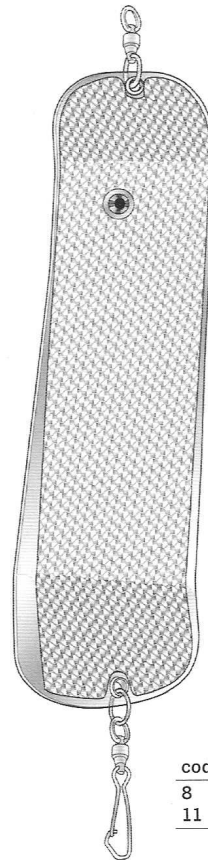

Flashers

These flashers are engineered to produce a rolling action that attracts fish by sight and sound. This full rotating motion spins the bait for maximum results. Life-like 3-D eyes are featured on both sides of a brilliantly colored blade. Blades are available in fluorescent red, chartreuse, lime green and bright chrome; and, they are finished in a variety of patterns to include silver scale, silver prism and glow crushed pearl. Ball bearing swivels with welded rings are used at both ends of the flasher.

NO. F

Packed 1 each per polybag with full back header card, 12 cards per inner box, 144 per case.

code	length	approx. case wgt.
8	8-1/2"	25 lbs.
11	11"	37 lbs.

code	blade color	top finish	bottom finish
CHES	chartreuse	silver scale	silver scale
CHGP	chartreuse	glow crushed pearl	silver scale
CRM	chrome	chrome	chrome
CRMGP	chrome	glow crushed pearl	silver scale
CRMSP	chrome	silver prism	silver scale
FRES	fluor. red	silver scale	silver scale
FRGP	fluor. red	glow crushed pearl	silver scale
GRNES	lime green	silver scale	silver scale
GRNGP	lime green	glow crushed pearl	silver scale

Luminous Six-Angle Squid Jig

Designed to reflect an aurora of colors this squid jig features a reflective luminous center tube encased in a clear 6-sided body. This 3-7/8" squid jig has two rows of needle sharp squid hooks. Body glows in the dark after exposure to light.

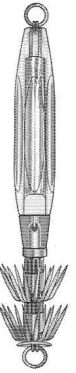

NO. SRIG6A-L

Packed 1 each per blister card, 12 cards per inner box, 288 per case. Approx. case wgt. 19 lbs.

Luminous Pick Squid Jig

Engineered specifically for attracting and catching squid this ever popular and time tested pick or "S" style squid jig is proven effective. Measuring 3-3/8" in length this squid jig features a luminous white body and two rows of needle sharp squid hooks. Body glows in the dark after exposure to light.



NO. SRIG-L

Packed 1 each per blister card, 12 cards per inner box, 288 per case. Approx. case wgt. 16 lbs.

Giant Luminous Pick Squid Jig

Ever popular and time tested this giant pick or "S" style squid jig is proven effective for large squid. Measuring 6-1/2" in length this squid jig features a luminous white body and three rows of needle sharp squid hooks. Body glows in the dark after exposure to light.

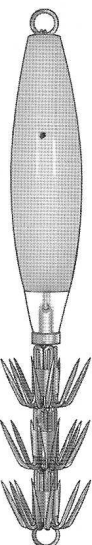

NO. SRIGGP-L

Packed 1 each per blister card, 12 cards per inner box, 144 per case. Approx. case wgt. 25 lbs.

Pacific Bucktail Lure

Life-like head and eyes, luminescent glow and the sparkle and flash created by the aurora bucktail streamer make these lures perfect natural bait imitations. Available in 4" and 6" herring and 4" needlefish, in four natural color patterns. Deadly for all salmon and a variety of gamefish including blue water species.

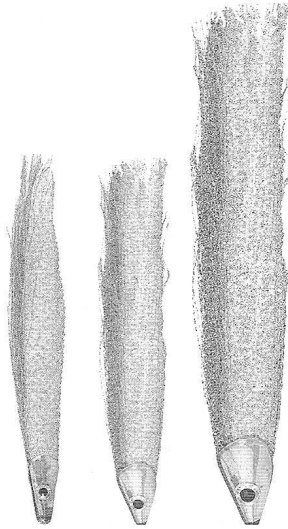

Needlefish 4" Herring 4" Herring 6"

code	color
BLK	black/white
BLU	blue/white
GRN	green/white
WHT	white/white

NO. LB
Packed 1 each per polybag with full back header card, 12 cards per inner box, 288 per case.

code	style	lure length	approx. case wgt.
H4	herring	4"	6 lbs.
H6	herring	6"	9 lbs.
N4	needlefish	4"	6 lbs.

Squid Head Insert

This solid plastic insert gives shape to a squid bait head and protects the vinyl lure from being damaged by the line.



NO. SQDHD

Packed 5 per polybag with insert card, 12 cards per inner box, 288 per case. Approx. case wgt. 6 lbs.

Squid Bait

A deadly meal to all gamefish! With its frantic, darting movements, this squid bait has a vivacious tentacle tail and inviting hand painted eyes fish can't say no to. Made of extra strong vinyl, it is available in 23 fish attracting colors. **Color codes listed in chart below.**

NO. SQD
Packed 3 per polybag with full back header card, 12 cards per inner box, 288 per case. Approx. case wgt. 11 lbs.

10-Pack

NO. SQDT (carded)
Packed 10 per polybag with header card, 12 cards per inner box, 144 per case. Approx. case wgt. 13 lbs.



Rigged Squid Bait

Rigged squid bait is a feast for salmon and other trophy gamefish. Rigged with a squid head insert and two 4/0 nickel Octopus hooks that are tied with 40-lb test leader, this bait is available in 23 fish attracting colors. **Color codes listed in chart below.**

NO. SQDR
Packed 1 per polybag with full back header card, 12 cards per inner box, 288 per case. Approx. case wgt. 9 lbs.

Mini Squid Bait

Irresistible to all gamefish this 2-1/2" mini squid bait is made of extra strong vinyl that resists tears. With a pulsating tentacle tail and large painted eyes, it is available in 23 fish attracting colors. **Color codes listed in chart below.**

NO. SQDM
Packed 4 per polybag with full back header card, 12 cards per inner box, 288 per case. Approx. case wgt. 7 lbs.



Squid Color Chart	
code	color
20	white oil sheen
21	blue/clear - silver glitter
22	black/purple/pink/glow
25	mexican flag
26	glow - rainbow glitter
27	blue/chartreuse/glow
29	chartreuse
30	blue scale/chartreuse
31	pink
32	orange scale/hot pink
33	blue spatter back/glow
34	blue/green
35	green spatter back/glow
36	hot pink
37	green spatter back/chartreuse/glow
38	olive drab/red/glow
39	black/glow - silver glitter
40	brown spatter back/orange/glow
47	green/chartreuse
48	fluor. red spatter back/chartreuse/glow
49	glow/hot pink bands
51	glow
52	purple haze

Sand Dab Rig

This popular 60", 5-drop flounder rig features size 1/0 hooks tied on 4" arms. Finished with a barrel swivel for mainline hook-up and an interlock snap for attaching a sinker.

NO. RGSD
Packed 1 rig per polybag with insert card, 12 cards per inner box, 288 per case. Approx. case wgt. 10 lbs.



Surf Leader

These 36" monofilament nylon leaders tied with two dropper loops feature a barrel swivel for mainline hook-up and a snap swivel for a quick and easy way to attach a sinker.

NO. 341
Packed 12 leaders per polybag with header card, 12 bags per inner box, 288 per case.

code	test	approx. case wgt.
10	10 lb.	18 lbs.
15	15 lb.	19 lbs.
20	20 lb.	22 lbs.
30	30 lb.	26 lbs.
40	40 lb.	34 lbs.

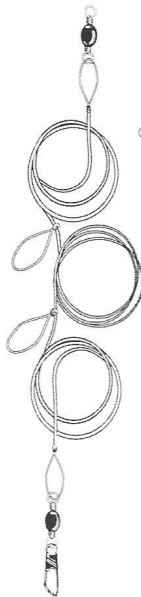

Mono Shrimp Fly

This exclusive monofilament shrimp fly features our unique through-eye design and strands of aurora glitter for that real bait flash. The fluorescent head is wrapped and epoxy sealed for durability. Tied on a size 7/0 hook.

NO. SFM
Packed 12 flies per polybag with header card, 12 bags per inner box, 300 per case. Approx. case wgt. 22 lbs.

code	streamer colors	head color
BWR	blue/white	fluorescent red
PYY	pink/yellow	fluorescent yellow
RYR	red/yellow	fluorescent red

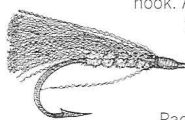

code	streamer color	body color
BW	blue	white
PY	pink	yellow
RY	rainbow	yellow
RY	red	yellow

Mono Shrimp Fly Rig

Two of our exclusive through-eye shrimp flies complement this proven monofilament nylon leader. The flies are tied on 7/0 hooks and feature wrapped fluorescent heads and strands of aurora glitter for the flash of real bait. Complete with barrel swivel for mainline hook-up and a snap swivel for attaching a sinker.

code	streamer colors	head color
BWR	blue/white	fluor. red
PYY	pink/yellow	fluor. yellow
RYR	red/yellow	fluor. red



NO. SFRM

Packed 1 rig per polybag with insert card, 12 cards per inner box, 600 per case. Approx. case wgt. 13 lbs.

Shrimp Fly Rig

For trolling, jigging or jetty fishing, this rig has two handcrafted shrimp flies tied on 7/0 hooks and rigged to a monofilament nylon leader. Complete with a barrel swivel for mainline hook-up and a snap swivel for attaching a sinker.

code	streamer/body colors
BW	blue/white
PY	pink/yellow
RY	rainbow/yellow
RY	red/yellow

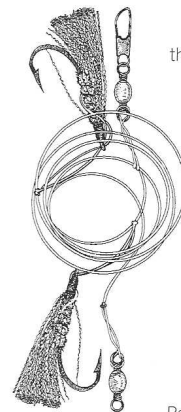

NO. 70

Packed 1 rig per polybag with insert card, 12 cards per inner box, 600 per case. Approx. case wgt. 25 lbs.

Rock Cod Rig with Vinyl Skirts

Featuring fluorescent red and chartreuse vinyl skirts, this rock cod rig can be used with or without bait. Tied with 80-lb test monofilament nylon, this rig has two 7/0 nickel Octopus hooks and a barrel swivel for mainline hook-up and a snap swivel for attaching a sinker.

NO. 604VS-7/0
Packed 1 rig per polybag with insert card, 12 cards per inner box, 288 per case. Approx. case wgt. 26 lbs.

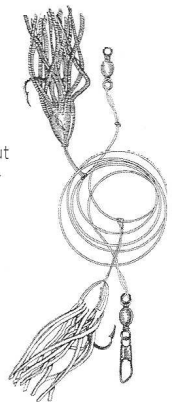

Rock Cod Rig

Tied with 80-lb test monofilament nylon, this popular rock cod rig features two forged nickel Octopus hooks. It comes complete with a barrel swivel for mainline hook-up and a snap swivel for attaching a sinker.

NO. 604
Packed 1 rig per polybag with insert card, 12 cards per inner box, 288 per case.

code	hook size	approx. case wgt.
3/0	3/0	12 lbs.
4/0	4/0	14 lbs.
5/0	5/0	15 lbs.
6/0	6/0	16 lbs.
7/0	7/0	17 lbs.



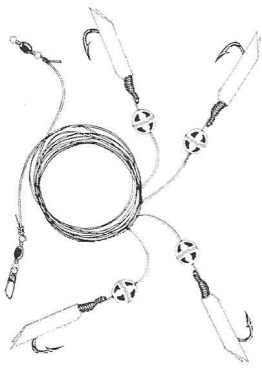

Fish Skin Jig Rig

These mackerel skin lures have a tantalizing look that provoke fish to strike! Features of the fish catching rig are a luminous bead on each drop, painted fluorescent red heads, a nickel barrel swivel for mainline hook-up and nickel snap swivel for attaching weight.

NO. JRFS

Packed 1 rig per polybag with insert card, 12 cards per inner box, 240 per case.

code	drops	hook size	approx. case wgt.
7-14	7	14	7 lbs.
7-12	7	12	7 lbs.
7-10	7	10	7 lbs.
6-8	6	8	7 lbs.
4-6	4	6	7 lbs.

Aurora Glow Skin Jig Rig

A deadly rig! Made to simulate baitfish, these Aurora Glow skin lures are luminous for deep water jigging. Other features include a luminous bead on each drop, painted fluorescent red heads, a nickel barrel swivel for mainline hook-ups and a nickel snap swivel for attaching a sinker.

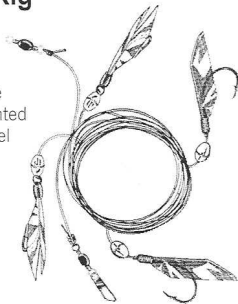

NO. JRGS

Packed 1 rig per polybag with insert card, 12 cards per inner box, 240 per case.

code	drops	hook size	approx. case wgt.
7-14	7	14	7 lbs.
7-12	7	12	7 lbs.
7-10	7	10	7 lbs.
6-8	6	8	7 lbs.
4-6	4	6	7 lbs.



Barbless Sturgeon Leader

This leader is designed to reduce harm to oversize and sub-legal sturgeon. Features include one single point barbless Octopus hook tied with braided line.

NO. SL

Packed 5 pieces per polybag with insert card, 12 cards per inner box, 480 per case.

code	hook size	approx. case wgt.
6/0	6/0	18 lbs.
7/0	7/0	18 lbs.

Sturgeon Rig

A proven sturgeon getter, this rig features two hooks on a single wire loop separated by fluorescent red beads. The 36" wire leader is complete with barrel swivel for mainline hook-up.

NO. RGSTRG

Packed 1 rig per polybag with insert card, 12 cards per inner box, 240 per case.

code	hook size	approx. case wgt.
6/0	6/0	8 lbs.
7/0	7/0	8 lbs.



Halibut Leader

Designed for use with herring bait, this leader features nickel Octopus hooks with an adjustable slip-tied lead hook for properly attaching the bait. This superb rig is made extra strong with a 60-lb test nylon-coated, stranded stainless steel wire leader and heavy-duty crimped sleeves.



NO. LDRH

Packed 1 leader per polybag with insert card, 12 cards per inner box, 240 per case

code	hook sizes	approx. case wgt.
6/0-7/0	6/0-7/0	7 lbs.
7/0-8/0	7/0-8/0	8 lbs.
8/0-9/0	8/0-9/0	10 lbs.
9/0-10/0	9/0-10/0	11 lbs.

Halibut Spreader Bars

When using bait, this stainless steel wire spreader bar greatly increases your ability to catch halibut and other bottom fish. The spreader bar is most often fished with two hooks on a 2' to 4' wire or monofilament leader attached to the spreader's long arm. Weight is hung from the short arm while the mainline attaches to the swivel at the juncture.

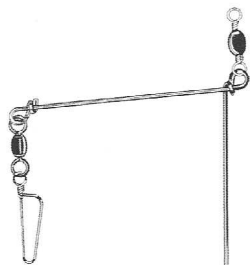

NO. HSB

Packed 1 each per card, 12 each per inner box, 144 per case.

code	long arm	short arm	approx. case wgt.
S	12"	6"	20 lbs.
L	20"	8"	28 lbs.

Luminescent Double Drop Mono Rig

This rig is made with 250-lb test monofilament nylon and features two swivel attached 8" drops; each with a 4/0 corkscrew swivel and 3-1/2" length of luminescent tubing. Assembled with crane swivels, a sinker pin release and heavy duty swaged sleeves. Measures 24" in length.

NO. RXDDML

Packed 1 rig per polybag with fold-over header card, 12 cards per inner box, 288 per case. Approx. case wgt. 23 lbs.



Double Drop Wire Rig

Made with 60-lb test, nylon coated, multi-strand stainless steel wire, this rig features two swivel attached 5" drops; each with an interlock snap. Assembled with red fluorescent beads, crane swivels, an interlock snap sinker release and heavy-duty swaged sleeves. Measures 24" in length.

NO. RXDDWR

Packed 24 rigs with individual labels per ring, 6 rings per polybag, 20 bags per case. Approx. case wgt. 53 lbs.



Double Drop Mono Rig

This rig is made with 60-lb test monofilament nylon and features two swivel attached 5" drops; each with an interlock snap. Assembled with red fluorescent beads, crane swivels, an interlock snap sinker release and heavy-duty swaged sleeves. Measures 24" in length.

NO. RXDDMR

Packed 24 rigs with individual labels per ring, 6 rings per polybag, 20 bags per case. Approx. case wgt. 49 lbs.



Mono Spreader Bar

Use this spreader bar to keep your bait from tangling with the sinker when lowering it to the bottom. Attach your bait to the long arm and your weight to the short arm while the mainline attaches to the swivel at the juncture. This spreader bar is made with 250-lb test monofilament nylon, a 4/0 corkscrew swivel and a 3-1/2" length of luminescent tubing.

NO. MSBL

Packed 1 each per polybag with fold-over header card, 12 each per inner box, 288 per case. Approx. case wgt. 20 lbs.



Double Drop Spreader Arm Bottom Rigs

Made with 60-lb test, nylon-coated, multi-strand stainless steel wire, this 19" surf and pier rig is constructed with two 2-3/4" free-turning wire spreader arms which allow tangle-free bait movement! Assembled with red fluorescent beads, barrel swivel for mainline hook-up and an interlock snap for sinker attachment.

NO. 1040

Packed 2 per polybag with insert card, 12 cards per inner box, 240 per case. Approx. case wgt. 10 lbs.

NO. 1040R

Packed 24 rigs with individual labels per ring, 6 rings per polybag, 12 bags per case. Approx. case wgt. 19 lbs.

Double Drop Mono Bottom Rig

Perfect for surf, bay, river or pier, this rig is made with 60-lb test monofilament nylon and features two tied 5" drops; each with an interlock snap. Assembled with barrel swivels, connecting link sinker release and heavy-duty swaged sleeves. Measures 19" in length.

NO. RXBDDMR

Packed 24 rigs with individual labels per ring, 6 rings per polybag, 20 bags per case. Approx. case wgt. 36 lbs.



Cricket Cup

Designed for ease of use, this plastic cricket cup features multiple air vents on top and sides and climbing ledges to help prevent suffocation. Complete with convenient dispenser outlet; simply twist the top to open and close.

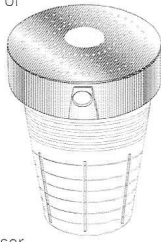

NO. CRKTC

Packed 1 each with a stick-on label, 24 per inner box, 72 per case. Approx. case wgt. 14 lbs.

Cricket Tubes

These easy to use cricket tubes feature a plastic nozzle dispenser and snap closure fill cap. Tubes are constructed of enameled diamond grid steel wire to allow for climbing and air circulation.

A carry cord is threaded through dispenser and fill cap to secure components.

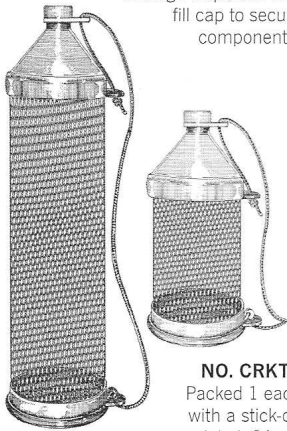

NO. CRKTT

Packed 1 each with a stick-on label, 24 per inner box.

	code	length	dia.	each/ case	approx. case wgt.
S	6-1/2"	2-1/2"	7/2	72	14 lbs.
L	10-1/2"	2-1/2"	48	14 lbs.	

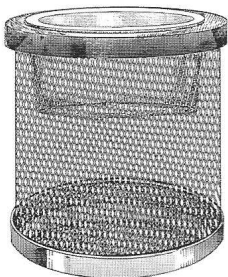

Cricket Basket

This cricket basket features an open-top, reach-in design with a sliding inner sleeve to prevent escape. The basket's molded plastic top and bottom secure enameled diamond grid steel wire sides that allow for climbing and air circulation. Complete with carry handle it measures 6" in diameter and 6" tall.

NO. CRKTB

Packed 1 each with a stick-on label, 12 per case. Approx. case wgt. 8 lbs.

Minnow Trap

Proven effective, the concave inward entrances funnel minnows into the trap. Vinyl-coated or zinc-plated to prolong use they are constructed with diamond grid steel wire welded to strong steel ring framing.

Consisting of two stackable sections for space saving storage they measure 9" in diameter at trap center with an assembled length of 16-1/2".

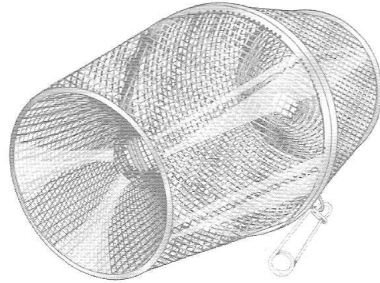
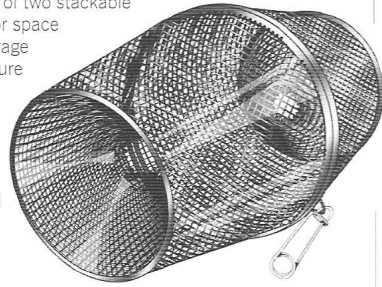

NO. MTW (vinyl-coated)

NO. MTWG (galvanized)

Packed 1 each with fold-over tag, 6 per inner box, 12 per case. Approx. case wgt. 21 lbs.

Crayfish Trap

Cone shaped inward entrances funnel crayfish into the trap and by design makes escape difficult. Vinyl-coated to prolong use it is constructed with diamond grid steel wire welded to strong steel framing.

Consisting of two stackable sections for space saving storage it measures 9" in diameter at trap center with an assembled length of 16-1/2".

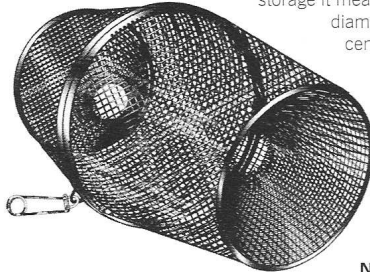

NO. MTWC

Packed 1 each with fold-over tag, 6 per inner box, 12 per case. Approx. case wgt. 21 lbs.

Trap Extension

This 15" extension section is used in conjunction with the minnow trap to increase capacity or for use as an eel pot. Complete with assembly clip it may also be used to extend the crayfish trap. Vinyl-coated to prolong use it is constructed with diamond grid steel wire welded to strong steel framing.

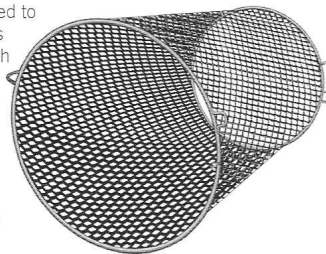

NO. MTWEWT

Packed 1 each with fold-over tag, 4 per case. Approx. case wgt. 8 lbs.

Minnow Trap Utility Clip

Quickly and easily assemble sections of the minnow or crayfish trap or the trap extension. Just squeeze to open; spring-action automatically returns the clip to the closed and locked position.

NO. MTWCLIP

Packed 2 clips per polybag with header card, 24 bags per inner box, 240 per case. Approx. case wgt. 14 lbs.



Monofilament Nylon Cast Nets with Bait Bucket

Each cast net is bonus packed in a bait bucket with a carrying handle, removable lid, an extra large bait access door with an exclusive locking system and built-in portable aerator clip slot and hose port. Designed to fully open and spread flatter, these 3/8" mesh nylon monofilament cast nets are weight balanced for better casting and sinking action and feature an extra long hand line.

NO. CNMB

Packed 1 each per plastic carry bucket with stick-on label, 6 per case.

code	radius	approx. case wgt.
3	3'	26 lbs.
4	4'	31 lbs.
5	5'	37 lbs.
6	6'	43 lbs.
7	7'	48 lbs.
8	8'	54 lbs.

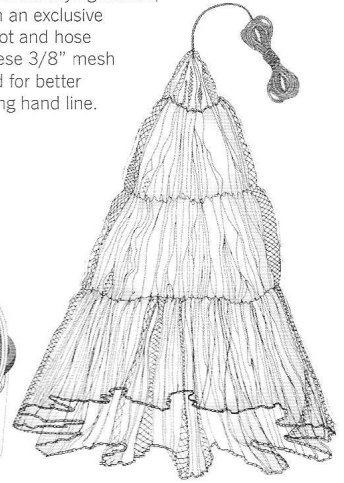

Monofilament Nylon Cast Nets with Carry Box

Designed to fully open and spread flatter, these 3/8" mesh monofilament nylon cast nets are weight balanced for better casting and sinking action. Features include nylon monofilament bail lines with a heavy-duty nickel crane swivel, solid braid lead line, extra long braided hand line and rot resisting selvage.

NO. CNM

Packed 1 each per plastic carry box with insert label.

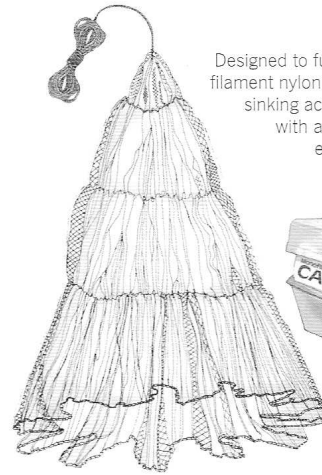

code	radius	each/ case	approx. case wgt.
3	3'	10	41 lbs.
4	4'	10	51 lbs.
5	5'	10	61 lbs.
6	6'	5	35 lbs.
7	7'	5	41 lbs.
8	8'	5	46 lbs.

Minnow Seines

Rugged and reliable, these long lasting minnow seines give fishermen the added edge in trapping bait. Made with non-absorbent, black polyethylene netting that resists rot and mildew. Featuring durable high density foam floats, these minnow seines are available in several lengths in both 1/8" and 1/4" mesh.

NO. MSF (1/8" mesh)

NO. MS (1/4" mesh)

Packed 1 each per polybag with insert label, 6 per case.

code	size	MSF approx. case wgt.	MS approx. case wgt.
4x4	4'x4'	5 lbs.	5 lbs.
4x6	4'x6'	7 lbs.	6 lbs.
4x8	4'x8'	9 lbs.	8 lbs.
4x10	4'x10'	11 lbs.	9 lbs.
4x12	4'x12'	13 lbs.	11 lbs.
4x15	4'x15'	16 lbs.	14 lbs.
4x20	4'x20'	21 lbs.	18 lbs.
4x25	4'x25'	23 lbs.	22 lbs.
4x30	4'x30'	27 lbs.	26 lbs.

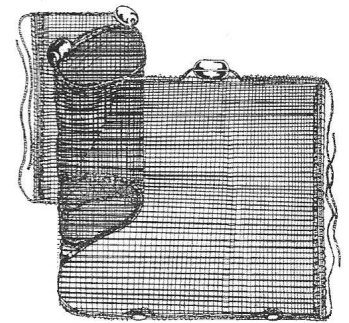

Umbrella Minnow Net

A great way to catch minnows and other bait, this folding umbrella drop net sets up and takes down quickly and easily. Constructed with a non-absorbent, 1/4" mesh, black polyethylene netting secured to a steel wire frame, it streams through the water with ease. Ideal for piers and docks, it measures 40" x 40".

NO. MUN

Packed 1 each per polybag with header card, 12 per case. Approx. case wgt. 18 lbs.

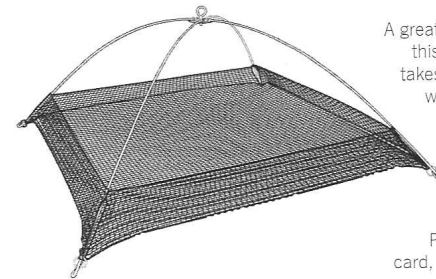



Collapsible Wire Baskets

Constructed of 5/8" wire mesh with a reinforcement ring and sturdy wire handles, these collapsible wire baskets feature spring-loaded trap doors on top and bottom for easy loading and unloading.

Packed 1 each per printed polybag.

NO.	dia.	depth	each/ case	approx. case wgt.
W6	13"	18"	24	30 lbs.
W8	14"	25"	24	36 lbs.
W9	19"	30"	12	28 lbs.

Clamp-On Wire Basket

The steel clamp of this collapsible, 5/8" wire mesh basket makes it easy to attach or remove from the boat. It has spring-loaded trap doors on top and bottom for easy access and retrieval, bottom reinforcement ring and a sturdy wire handle. Measures 14" dia. x 25" deep.

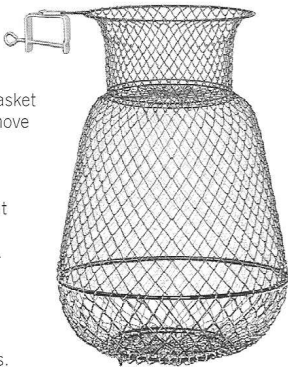

NO. C2D

Packed 1 each per printed polybag, 12 per case. Approx. case wgt. 48 lbs.

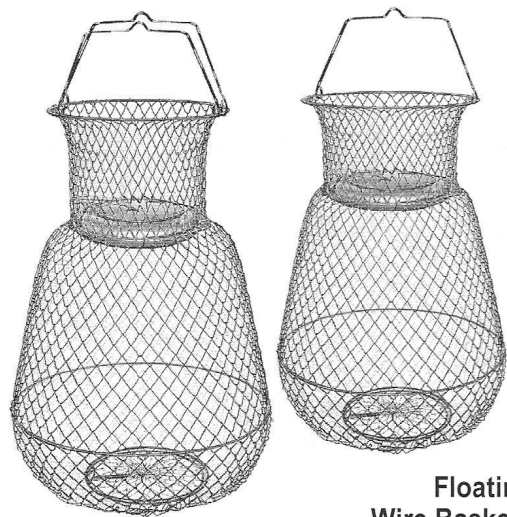

Floating Wire Baskets

Molded plastic trap door will float this collapsible 5/8" wire mesh basket should it come lose from its mooring. Other features include a spring-loaded bottom trap door, bottom reinforcement ring and a sturdy wire handle.

Packed 1 each per printed polybag, 12 per case.

NO.	dia.	depth	approx. case wgt.
F2D	14"	25"	21 lbs.
F9D	19"	30"	31 lbs.

4-Qt. Bait Bucket

Compact 4 quart size fits in coolers and live wells, yet is large enough for minnows, shrimp and leeches. Features include a removable lid with an extra large bait access door with an exclusive locking system, built-in portable aerator clip slot and hose port and sturdy carrying handle.

NO. BB4

Packed 1 each with stick-on label, 12 per case. Approx. case wgt. 9 lbs.

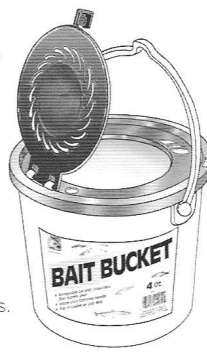

10-Qt. Bait Bucket 2-Piece

Two-piece, 10 quart inner/outer design allows water to be changed easily or the inner bucket to be tied to boat or dock for continuous bait aeration. Slotted drain port configuration channels water straight down to control splashing. Other features include built-in portable aerator clip slot and hose port and an extra large bait access door with an exclusive locking system plus sturdy carrying handles.

NO. BB210

Packed 1 each with stick-on label, 6 per case. Approx. case wgt. 16 lbs.

Bellows Aerator

Features include air stone, hose and convenient clip-on attachment. Operates on a single "D" cell battery with a compartment for storing a spare battery. Battery not included.

NO. MP500

Packed 1 each per blister card, 12 per inner box, 48 per case. Approx. case wgt. 21 lbs.

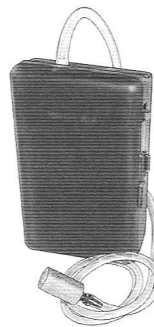

Piston Aerator

This power packed piston pump comes complete with air stone, hose and handy clip-on attachment that easily hangs right from your minnow bucket.

Features include a solid bar battery contact, rubber assembly gasket and a non-corrosive switch. Powered by dual "D" cell batteries. Batteries not included.

NO. MP700

Packed 1 each per blister card, 12 per inner box, 48 per case. Approx. case wgt. 21 lbs.

Replacement Aerator Stones

Maintain proper oxygen levels with these replacement aerator stones. This great item is designed to fit most battery operated live bait aerators. For fresh or saltwater use.

NO. MPRS

Packed 2 per blister card, 12 cards per inner box, 240 per case. Approx. case wgt. 15 lbs.



Jumbo Fish Spear

Designed for larger, heavier fish, this jumbo 5-prong spear measures 9-1/4" in length and 4-1/4" wide with 5" by 1/4" diameter tines. Constructed of tempered steel and finished in black enamel, this spear features razor sharp tips and sure-holding barbs.

NO. FFS5J

Packed 1 each per skin-pack card, 12 per inner box, 60 per case. Approx. case wgt. 42 lbs.

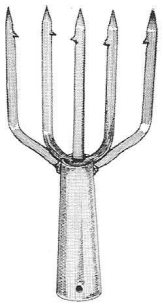

Fish Spears

Featuring razor sharp tips and sure-holding barbs, these fish spears are constructed of tempered steel and finished in black enamel to prevent corrosion. All three sizes have a drilled ferrule for mounting.

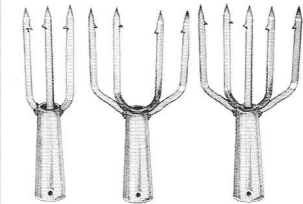

NO. FFS

Packed 1 each per skin-pack card, 12 per inner box, 120 per case.

code	no. of tines	tine length	width	overall length	approx. case wgt.
3	3	3"	1-5/8"	6-1/2"	30 lbs.
4	4	3-1/2"	3-1/2"	6-3/4"	37 lbs.
5	5	3-1/2"	3-1/2"	7"	42 lbs.

Frog Spear with Telescoping Handle

This 5 prong frog spear features a telescoping handle with 50", 69" and 90" settings secured by a strong push-button lock. Made tough with tempered steel, this gig has needle sharp points and sure-holding barbs.

NO. 5H

Packed 1 each with a stick-on label, 24 per case. Approx. case wgt. 29 lbs.



Frog Gig



With needle sharp points and sure-holding barbs, this gig is uniquely designed with a diamond pattern and a center prong. Measuring 7-1/2" overall, with 4-3/4" tines, it is made of tempered steel and has a black enamel finish that fights corrosion. It also has a drilled ferrule for easy mounting.

NO. 5D

Packed 1 each per skin-pack card, 12 per inner box, 120 per case. Approx. case wgt. 35 lbs.

Frog Spears

These frog spears have needle sharp points and strong cut barbs. Constructed of tempered steel, they are finished in black enamel to guard against corrosion. They also have a drilled ferrule for mounting.

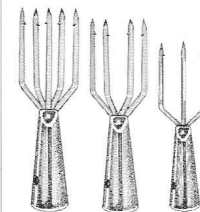

Packed 1 each per skin-pack card, 24 per inner box, 240 per case.

NO.	no. of tines	tine length	width	overall length	approx. case wgt.
3	3	2-3/4"	1-1/2"	4"	29 lbs.
4	4	2-3/4"	1-1/2"	5-1/4"	30 lbs.
5	5	2-3/4"	1-1/2"	5-1/4"	31 lbs.

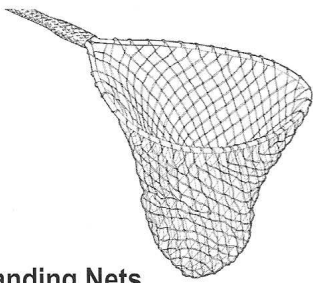

Landing Nets

Made with longer handles, these nets are designed for use from boat or bank or anywhere extra reach is necessary. Constructed with 1" diameter diamond embossed handles, strong 1/2" diameter teardrop-shaped bows, and finished with hand crafted black polyethylene netting.

Packed 1 each with fold-over tag, 3 per bundle.

NO.	handle length	hoop size	net depth	approx. case wt.
LN18F	18"	14" x 19"	24"	2 lbs.
LN24F	24"	16" x 22"	30"	3 lbs.
LN30F	30"	18" x 25"	30"	3 lbs.

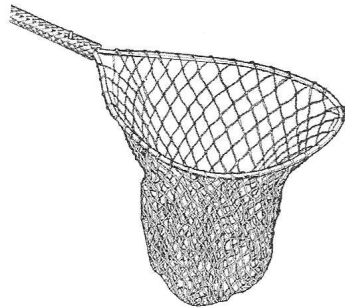

Telescoping Landing Net

Ideal for use from larger boats or anywhere extra reach is necessary, this midsize net features a telescoping handle with 26" and 44" settings secured by a strong push-button lock. The handle is constructed with 1-1/8" and 1" diameter diamond embossed tubing. Measuring 16" x 22" the teardrop-shaped bow is made with 1/2" tubing and features a 30" deep basket of durable black polyethylene netting.

NO. LN2644S

Packed 1 each with fold-over tag, 3 per bundle. Approx. case wt. 4 lbs.

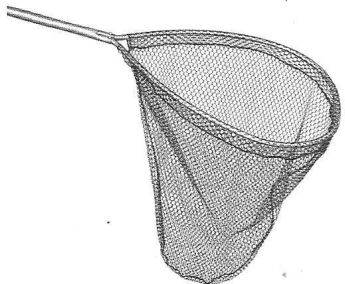

Knotless Landing Net

Made with a longer handle this net is designed for use from boat or bank or anywhere extra reach is necessary. This net features soft, supple, knotless nylon netting to minimize damage to fish during landing. Constructed with a 1" diameter diamond embossed handle and strong 1/2" diameter teardrop-shaped bow.

NO. LN30FNW

Packed 1 each with fold-over tag, 3 per bundle. Approx. case wt. 3 lbs.

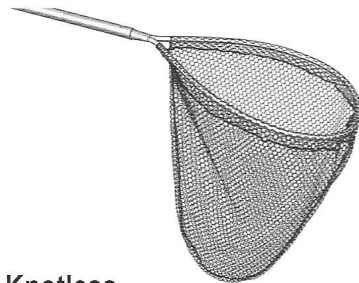

Knotless Telescoping Landing Net

Ideal for use from larger boats or anywhere extra reach is necessary, this midsize net features a telescoping handle with 26" and 44" settings secured by a strong push-button lock. The handle is constructed with 1-1/8" and 1" diameter diamond embossed tubing. Measuring 16" x 22" the teardrop-shaped bow is made with 1/2" tubing and features a 30" deep basket of soft, supple, knotless nylon netting to minimize damage to fish during landing.

NO. LN2644SNW

Packed 1 each with fold-over tag, 3 per bundle. Approx. case wt. 4 lbs.

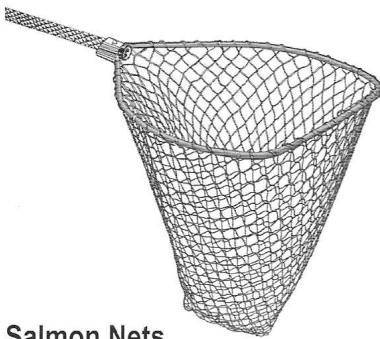

Salmon Nets

Designed with retractable handles for storage and transport, these salmon nets feature a channeled aluminum yoke for added strength. Constructed with 1-1/4" diameter diamond embossed handles, strong 5/8" diameter teardrop-shaped bows with double wall construction at the yoke, and finished with handcrafted black polyethylene netting. Features a comfortable black vinyl handgrip.

Packed 1 each with fold-over tag, 3 per bundle.

NO.	handle length	hoop size	net depth	approx. case wt.
LN36S	36"	22" x 25"	36"	5 lbs.
LN42S	42"	27" x 30"	48"	6 lbs.
LN48S	48"	30" x 33"	48"	7 lbs.

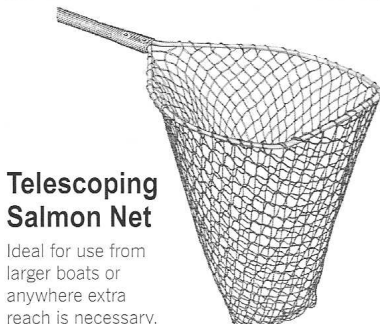

Telescoping Salmon Net

Ideal for use from larger boats or anywhere extra reach is necessary, this large size salmon net features a telescoping handle with 48" and 72" settings secured by a strong push-button lock. The handle is constructed with 1-1/4" and 1-1/8" diameter diamond embossed tubing and features a comfortable black vinyl handgrip. Measuring 27" x 30" the teardrop-shaped bow uses 5/8" tubing with double wall construction at the yoke and features a 48" deep basket of durable black polyethylene netting.

NO. LN4872S

Packed 1 each with fold-over tag, 3 per bundle. Approx. case wt. 7 lbs.

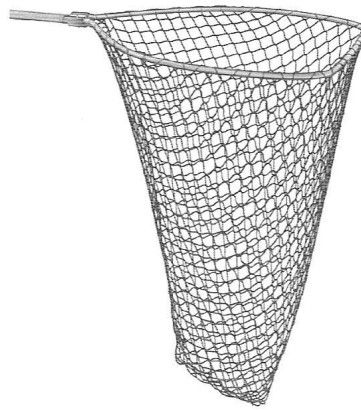

Knotless Salmon Nets

These salmon nets feature soft, supple, knotless nylon netting to minimize damage to fish during landing. Engineered with retractable handles for transport and storage and constructed with a channeled aluminum yoke for added strength. The 1-1/4" diameter diamond embossed handles are fitted to 5/8" diameter teardrop-shaped bows that feature double wall construction at the yoke for even greater strength. Finished with a comfortable black vinyl handgrip.

Packed 1 each with fold-over tag, 3 per bundle.

NO.	handle length	hoop size	net depth	approx. case wt.
LN36SNW	36"	22" x 25"	36"	6 lbs.
LN42SNW	42"	27" x 30"	48"	7 lbs.
LN48SNW	48"	30" x 33"	48"	8 lbs.

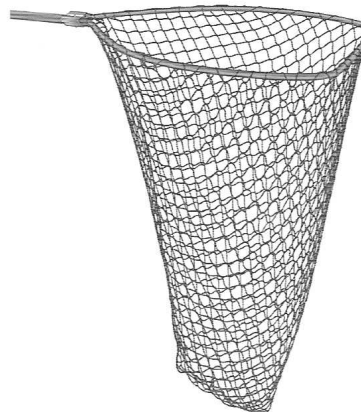

Black Knotless Salmon Net

Featuring strong, supple knotless netting to minimize damage to fish, this salmon net is designed with a 48" retractable handle for storage and transport and features a channeled aluminum yoke for added strength. Finished in black and constructed with 1-1/4" diameter diamond embossed handle, strong 5/8" diameter teardrop-shaped bow with double wall construction at the yoke. Features a black heavy-gauge soft vinyl handgrip. Hoop measures 30" x 33" with a 48" net depth.

NO. LN48SKN

Packed 1 each with fold-over tag, 3 per bundle. Approx. case wt. 7 lbs.

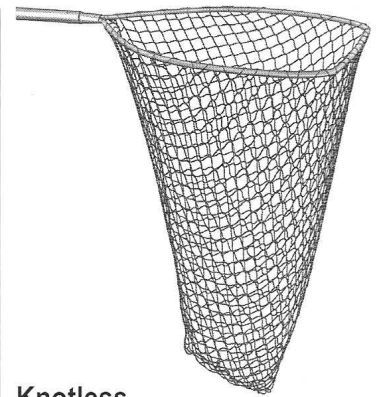

Knotless Telescoping Salmon Net

Ideal for use from larger boats, this salmon net features a telescoping handle with 48" and 72" settings secured by a strong push button lock and a 48" deep soft, supple, knotless nylon netting to minimize damage to fish during landing. The telescoping 1-1/8" into 1-1/4" diameter diamond embossed handle supports a 27" x 30" x 5/8" diameter bow that incorporates double wall construction at the yoke. Finished with a comfortable black vinyl handgrip.

NO. LN4872SNW

Packed 1 each with fold-over tag, 3 per bundle. Approx. case wt. 8 lbs.

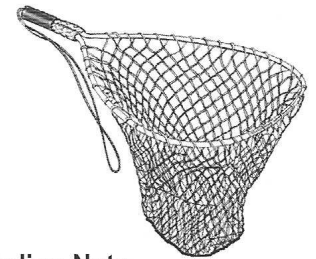

Wading Nets

Designed for wading, these short handled nets feature an elastic lanyard for shoulder carry or vest attachment. Constructed with 1" diameter diamond embossed handles, strong 1/2" diameter teardrop-shaped bows, and finished with hand-crafted black polyethylene netting. Features a black heavy-gauge soft vinyl handgrip.

Packed 1 each with fold-over tag, 3 per bundle.

NO.	handle length	hoop size	net depth	approx. case wt.
LN6F	6"	14" x 19"	24"	2 lbs.
LN9F	9"	16" x 22"	30"	2 lbs.
LN12F	12"	18" x 25"	30"	3 lbs.

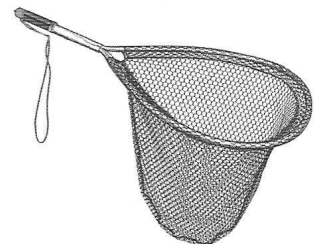

Knotless Wading Net

Designed for wading, this short handled net features an elastic lanyard for shoulder carry or vest attachment. Constructed with a 1" diameter diamond embossed handle, strong 1/2" diameter teardrop-shaped bow, and finished with a soft, supple, knotless nylon netting to minimize damage to fish during landing.

NO. LN9FNW

Packed 1 each with fold-over tag, 3 per bundle. Approx. case wt. 2 lbs.

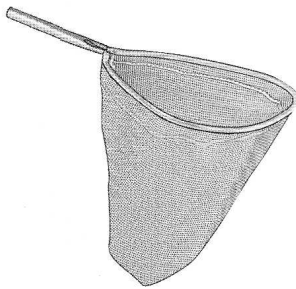

SN140S
knotless nylon

Knotless Nylon Telescoping Smelt and Shad Net

Designed to catch smelt, shad, herring, shrimp and other baitfish, this specialty net features a telescoping handle with 87" and 140" settings secured by strong push-button lock. The telescoping 1-1/8" into 1-1/4" diameter diamond embossed handle snaps into the 12" extension of its 20" x 19" x 1/2" diameter D-shaped bow. Available with 30" deep knotless nylon mesh netting.

NO. SN140S

(knotless nylon)

Packed 1 each with fold-over tag, 3 per bundle. Approx. case wgt. 7 lbs.

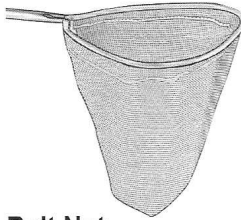

Bait Net

Designed for scooping shad, herring and other baitfish this bait net features 30" deep knotless nylon mesh netting. Measuring 6' in length with a 52" x 1-1/8" diameter diamond embossed handle and 20" x 19" x 1/2" diameter D-shaped bow.

NO. BN52F

Packed 1 each with fold-over tag, 3 per bundle. Approx. case wgt. 4 lbs.

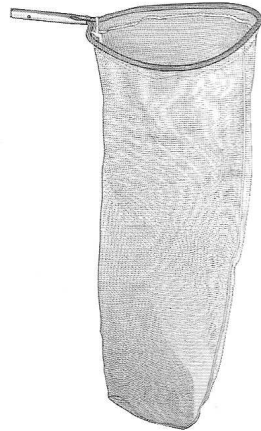

Smelt Surf Net

Designed specifically for use in the surf this smelt net features a 60" deep knotless nylon mesh netting for repeated scooping without risk of losing previously netted smelt. Measuring 6' in length with a 48" x 1-1/8" diameter diamond embossed handle that snaps into the 12" extension of its 20" x 19" x 1/2" diameter D-shaped bow.

NO. SN52F

Packed 1 each with fold-over tag, 3 per bundle. Approx. case wgt. 4 lbs.

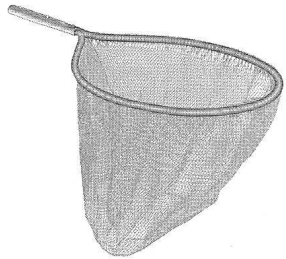

SN140SM
monofilament

Monofilament Nylon Telescoping Smelt and Shad Net

Designed to catch smelt, shad, herring, shrimp and other baitfish, this specialty net features a telescoping handle with 87" and 140" settings secured by strong push-button lock. The telescoping 1-1/8" into 1-1/4" diameter diamond embossed handle snaps into the 12" extension of its 20" x 19" x 1/2" diameter D-shaped bow. Available with 22" deep monofilament nylon netting.

NO. SN140SM

(monofilament nylon)

Packed 1 each with fold-over tag, 3 per bundle. Approx. case wgt. 7 lbs.

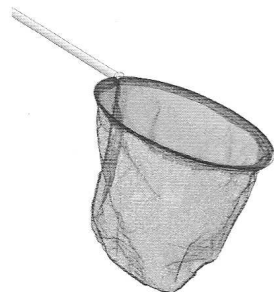

Butterfly Net

An ideal butterfly and scientific net, it features a super soft fine mesh netting that will not harm insects. Constructed with a 13" diameter steel wire hoop and 20" aluminum handle with 15" deep net.

NO. BFN1320

Packed 1 each with wrap-around pegboard card, 24 per case. Approx. case wgt. 10 lbs.

Retractable Cord Trout Net

Designed for stream fishing, the teardrop-shaped basket of this landing net has a 14-1/4" x 11" hoop opening and is 19" deep. Featuring a retractable cord with snap, this aluminum frame net measures 20" in length. Available in a natural finish with durable polypropylene netting.

NO. D3X

Packed 1 each with fold-over tag, 12 per bundle, 72 per case. Approx. case wgt. 27 lbs.

Trout Net

This aluminum frame landing net features a 12" x 10" hoop opening, 14" basket and measures 17-1/2" in length. Comfortable plastic grip is easy to handle even when wet. Elastic lanyard makes it convenient to carry.

NO. D3

Packed 1 each with fold-over tag, 12 per bundle, 144 per case. Approx. case wgt. 44 lbs.

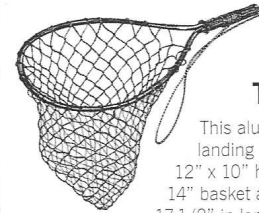

Black Trout Net

This aluminum frame landing net features a 12" x 10" hoop opening, 14" basket and measures 17-1/2" in length. Comfortable plastic grip is easy to handle even when wet. Elastic lanyard makes it convenient to carry.

NO. D3BLK

Packed 1 each with fold-over tag, 12 per bundle, 144 per case. Approx. case wgt. 45 lbs.

Scoop Nets

This wooden handle bait and crab scoop net features a circular hoop with a full sized, flat-bottomed basket of nylon netting.

Packed 1 each with stick-on label, 6 per inner box.

	hoop diameter	handle length	net depth	each/ case	approx. case wgt.
R6	6"	14"	5-1/4"	48	12 lbs.
R8	8"	14"	6-1/2"	48	14 lbs.
R10	10"	14"	8"	24	13 lbs.
R12	12"	16"	10"	24	14 lbs.
R14	14"	16"	11"	24	17 lbs.
L14	14"	36"	11"	12	15 lbs.

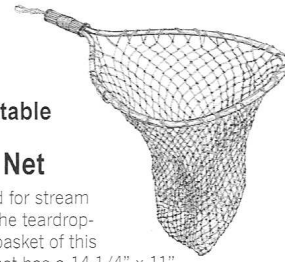

Bamboo Net

This lightweight trout net is conveniently sized for carrying, yet large enough for lunker trout. Crafted with a split bamboo laminate frame, soft nylon netting and an elastic lanyard for attaching to vest or belt. Net measures 20" in length. Hoop size is 13-1/2" x 8-1/2" and is 23" deep.

NO. NLWF

Packed 1 each per polybag with hang tag, 25 per case. Approx. case wgt. 14 lbs.

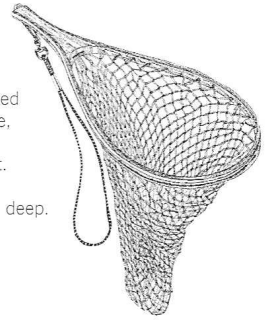

Classic Bamboo Net

Considered the standard, this classic trout net is crafted with a split bamboo laminate frame and soft nylon netting. A convenient elastic lanyard attaches to vest or belt. Net measures 23" in length. Hoop size is 15" x 11" and is 23" deep.

NO. BLW32

Packed 1 each per polybag with hang tag, 25 per case. Approx. case wgt. 14 lbs.



Catch & Release Bamboo Net

Designed for catch and release, this trout net features a knotless nylon mesh netting with an elongated net bottom so fish lay flat. Crafted with a split bamboo laminate frame, it has an elastic lanyard for attaching to vest or belt. Net measures 20" in length. Hoop size is 13-1/2" x 8-1/2" and is 8" deep.

NO. NLWFCR

Packed 1 each per polybag with hang tag, 25 per case. Approx. case wgt. 14 lbs.

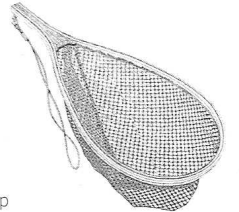

Catch & Release Classic Bamboo Net

Designed for catch and release, this classic trout net features a knotless nylon mesh netting with an elongated net bottom so fish lay flat. Crafted with a split bamboo laminate frame it has an elastic lanyard for attaching to vest or belt. Net measures 23" in length. Hoop size is 15" x 11" and is 9" deep.

NO. BLW32CR

Packed 1 each per polybag with hang tag, 25 per case. Approx. case wgt. 17 lbs.

Catch & Release Long Handle Bamboo Net

Both hoop and extra long 32" handle of this classic trout net are crafted with laminated split bamboo and feature knotless nylon catch and release netting. Ideal for use from a boat or anywhere extra reach is necessary. Net includes a clip-on elastic lanyard and measures 47" in length with a 15" x 11" hoop and 22" net depth.

NO. BLW32LHCR

Packed 1 each per polybag with hang tag, 10 per case. Approx. case wgt. 14 lbs.

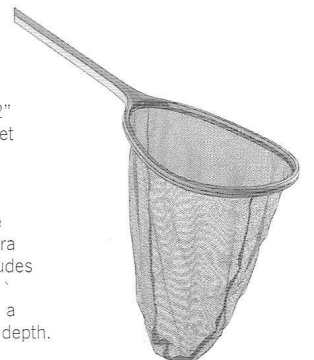

Minnow Dip Net

Great for bait buckets and live wells this minnow dip net is constructed of a one-piece wire frame and fine mesh netting. It measures 11" long and has a 4-1/4" x 3-3/4" D-shaped hoop.

NO. DN109

Packed 12 each per bundle, 720 per case. Approx. case wgt. 37 lbs.

NO. DN109C (label)

Packed 1 each with label, 12 per bundle, 720 per case. Approx. case wgt. 38 lbs.

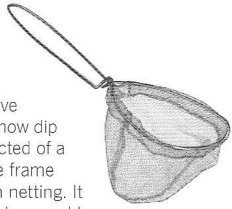

Fluorescent Orange Dip Net

Featuring a bright fluorescent orange mesh netting for easy visibility this minnow dip net is ideally suited for ice fishing. One-piece wire frame construction measures 11" long with a 4-1/4" x 3-3/4" D-shaped hoop.

NO. IFDN109

Packed 12 each per bundle, 720 per case. Approx. case wgt. 42 lbs.

NO. IFDN109C (label)

Packed 1 each with label, 12 per bundle, 720 per case. Approx. case wgt. 44 lbs.

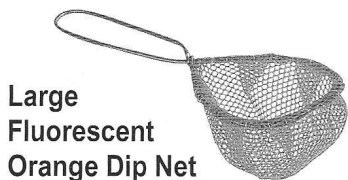

Large Fluorescent Orange Dip Net

The high visibility fluorescent orange mesh netting of this larger and stronger minnow dip net makes it ideal for ice fishing. One-piece heavy-gauge wire construction measures 11" long with a 4" x 5" D-shaped hoop.

NO. IFDNDLX

Packed 1 each with label, 12 per bundle, 480 per case. Approx. case wgt. 55 lbs.



Large Minnow Dip Net

Featuring fine mesh netting this large size minnow dip net is made stronger with one-piece, heavy-gauge wire frame construction. It measures 11" long and has a 4" x 5" D-shaped hoop.

NO. DNDLX

Packed 1 each with label, 12 per bundle, 480 per case. Approx. case wgt. 48 lbs.



Jumbo Bait Dip Net

Built to handle large bait this jumbo dip net is constructed of a one-piece, extra heavy-gauge wire and features a deep basket mesh net. It measures 16" long and has a 5" x 6" D-shaped hoop.

NO. DNJ

Packed 1 each with label, 12 per bundle, 120 per case. Approx. case wgt. 35 lbs.

Floating Minnow Dip Net

Featuring a fluorescent red and white floating foam handle this dip net is ideal for bait bucket and live well. Constructed of one-piece wire frame and fine mesh netting it measures 11" long and has a 4-1/4" x 3-3/4" D-shaped hoop.

NO. DN109F

Packed 1 each with label, 12 per bundle, 240 per case. Approx. case wgt. 17 lbs.



Plastic Bait Scoop

Ideal for leeches and minnows this plastic bait scoop has a D-shaped basket with drain holes and features a hook remover at the end of the handle. It measures 8-1/2" long and has a 3-1/4" x 3-1/4" x 1-3/8" deep basket.

NO. PBS

Packed 2 each with stick-on label, 288 per case. Approx. case wgt. 19 lbs.

Deluxe Plastic Fish Billie Club

Made of strong highly durable plastic, this deluxe billie club is the best way to subdue any large catch. The knuckle guard is designed to protect your hand and also prevents the club from rolling around on your boat deck. The contour fitted grip will prevent the club from slipping out of your hand and insures subduing the fish with one swing.

NO. FBPC

Packed 1 each with hang tag, 6 each per inner box, 48 per case. Approx. case wgt. 49 lbs.

Fish Billie Club

This practical billie club is the quick and humane way to subdue your catch. Lathed from fine hardwood, it has a nylon lanyard at the handle for safety. Measures 15-3/4" in length by 1-9/16" in diameter.

NO. FBC

Packed 1 each with a stick-on label, 48 per case. Approx. case wgt. 33 lbs.



Commercial Gaffs

These heavy-duty gaffs are what commercial fishermen use. The proven hook design makes gaffing safer, easier and more accurate. Also used as a clubbing device it is constructed of solid hardwood and has an easy to grip handle. The strong, stainless steel hook is locked in place with a stainless steel sleeve.

NO. CG

Bulk packed 1 each with tip protector.

code	length	pack	case approx. wgt.
24	24"	24	22 lbs.
32	32"	20	23 lbs.

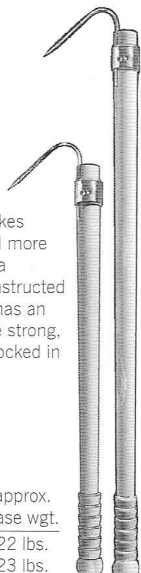

Replacement Nets

Hand crafted, these black polyethylene replacement nets will not fade or rot. Polyethylene netting is more tangle resistant and draws through the water easier than most other materials.

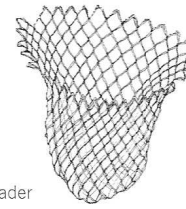

Packed 1 each per polybag with header card, 12 bags per inner box, 240 per case.

NO.	replacement net for:	approx. case wgt.
RN24B	LN6F, LN18F	28 lbs.
RN30B	LN9F, LN24F, LN2644S	34 lbs.
RN36B	LN12F, LN30F	40 lbs.
RN36HDB	LN36S	65 lbs.
RN48HDB	LN42S, LN48S, LN4872S	77 lbs.
RN30SN	SN140S	47 lbs.

Knotless Replacement Salmon Nets

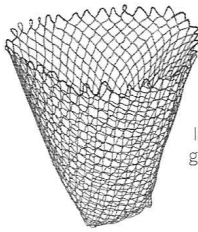

These soft, supple, knotless nylon replacement nets are designed to minimize damage to salmon and other large fish during landing. Strong, drag resistant mesh grid measures 1-1/2" x 1-1/2". Made to fit Danielson® and most other salmon sized nets.

Packed 1 each per polybag with header card, 12 bags per inner box, 240 per case.

NO.	replacement net for:	approx. case wgt.
RN36HDNWB	LN36SNW	65 lbs.
RN48HDNWB	LN42SNW, LN48SNW, LN48SKN	77 lbs.
RN48X60HDNWB	LN42SNW, LN48SNW, LN48SKN	92 lbs.

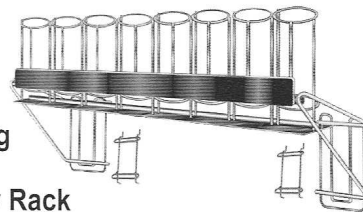

Landing Net Display Rack

Allows an upright presentation of landing nets or rod and reel combos with either pegboard or slotwall fixtures. Constructed of vinyl-coated steel wire this 22" wide rack features 8 tubes that will accept handles up to 1-5/8" diameter. Slotwall use requires LNR8SWA Slotwall Adapters.

NO. LNR8

Packed 1 each per polybag, 6 per case. Approx. case wgt. 27 lbs.

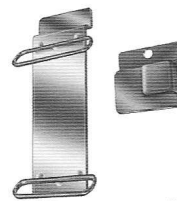

LNR8 Slotwall Adapter

Brackets adapt LNR8 Landing Net Display Rack to slotwall systems. Features include security clips for locking brackets in place.

NO. LNR8SWA

Packed 1 pair per polybag, 36 pair per case. Approx. case wgt. 30 lbs.

Landing Net Floor Display Rack

Multi-level 66-slot grids allow upright display of a number of landing nets in various combinations of styles and sizes. Casters allow easy portability and are spaced 20" apart on each end to insure stability. Bottom mesh grid prevents long-handled nets from reaching the floor. Rack measures 48" wide and 34" tall with an 8" grid width.



NO. LNFDF

Packed 1 display per case. Approx. case wgt. 24 lbs.

Lip Grip with Scale

Lip Grip is a fish landing, handling and weighing tool. Features include a positive locking jaw that tightens with the weight of the fish and a cushioned handle that swivels to reduce the torque. A calibrated scale weighing up to 30 lbs. is incorporated into the stainless steel housing while an adjustable lanyard secures the tool to wrist. Excellent for catch and release applications.

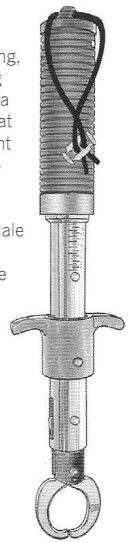

NO. LG

Packed 1 each per clam-pack, 12 packs per inner box, 48 per case. Approx. case wgt. 50 lbs.



55-lb T-Handle Scale

Comfortable T-handle design and a light weight, aluminum housing make this 55-lb spring scale ideal for weighing big fish. Engineered for quality and accuracy, it's easy to read gauge has a sliding ring for precise measurement in pounds and kilograms. Scale includes a folding ring for hanging.

NO. STH55

Packed 1 each per blister card, 12 cards per inner box, 96 per case. Approx. case wgt. 38 lbs.

100-lb Spring Scale

This rugged, metal spring scale is for the big ones! Reading in both pounds and kilograms, it features a polished brass face plate and strong chrome weighing hook and hanging ring.

NO. 112

Packed 1 each per skin-pack card, 12 cards per inner box, 36 per case. Approx. case wgt. 27 lbs.



50-lb Spring Scale

Engineered for quality and accuracy, this rugged, metal spring scale weighs in both pounds and kilograms. It has a strong chrome weighing hook, hanging ring and polished brass face plate.



NO. 56

Packed 1 each per skin-pack card, 12 cards per inner box, 60 per case. Approx. case wgt. 31 lbs.

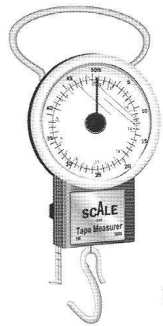

50-lb Easy-Read Scale

No more doubts about how much the big one really weighs when you use this deluxe fish scale with a folding handle. Fitting conveniently into your tackle box, it weighs fish up to 50 pounds. An easy to read dial gauge measures in both pounds and kilograms. Complete with 39" retractable tape measure.

NO. DS50R

Packed 1 each per blister card, 10 per inner box, 100 per case. Approx. case wgt. 39 lbs.

50-lb Deluxe Scale

Precise springs measuring in pounds and kilograms guarantee the accuracy of this deluxe 50-lb scale. Lightweight and easy to store, it has a chrome weighing hook and molded handle for a comfortable grip and 39" retractable tape measure.

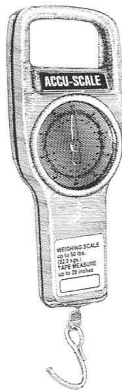

NO. DS50

Packed 1 each per blister card, 10 per inner box, 100 per case. Approx. case wgt. 46 lbs.

8-lb Pocket Scale

This compact scale features a 24" retractable tape measure and fold-up weighing hook. Measuring in both kilograms and pounds, it is great for panfish and trout. Slips easily into vest pocket.

NO. 259

Packed 1 each per blister card, 12 per inner box, 120 per case. Approx. case wgt. 14 lbs.

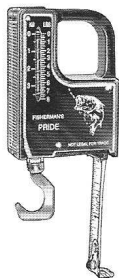

28-lb Pocket Scale

Take all of your trophy bass or trout's vital stats with this lightweight 28-lb scale. Measuring in both kilograms and pounds, it features easy to read numerals, a 38" retractable tape measure and a fold-up weighing hook.

NO. 228

Packed 1 each per blister card, 12 per inner box, 144 per case. Approx. case wgt. 33 lbs.



Polycord Stringers

What a value! These promotional fish stringers feature twisted, heavy-duty polycords and rust-resistant rings and threading needles.

NO. 9403PT

Packed 1 each per polybag with header card, 24 per inner box, 288 per case.



code	length	approx. case wgt.
6	6 ft.	12 lbs.
9	9 ft.	15 lbs.
12	12 ft.	17 lbs.

NO. PCSB (bulk)

Packed 50 each per bag.

code	length	each/case	approx. case wgt.
6	6 ft.	1200	32 lbs.
9	9 ft.	600	23 lbs.
12	12 ft.	600	27 lbs.

Heavy-Duty Polycord Stringer

An extra heavy-duty, 1/4" twisted polycord makes this 7' stringer ideal for larger fish. Features include a brass-plated ring and threading needle.



NO. 4095

Packed 1 each per polybag with header card, 12 per inner box, 144 per case. Approx. case wgt. 20 lbs.

Braided Polycord Stringer

A great value! This promotional 6' fish stringer features a braided, 1/8" heavy-duty polycord and rust resistant ring and threading needle.



NO. SBPCP6

Packed 1 each per polybag with header card, 12 per inner box, 480 per case. Approx. case wgt. 24 lbs.

Diamond Braid Polycord Stringers

Avid fishermen cannot do without these premium quality stringers! Constructed with diamond braided, 3/16" polycords for incredible strength and flexibility, they have brass-plated rings and tapered threading needles for stringing.



NO. SBPC

Packed 1 each per polybag with header card, 12 per inner box.

code	length	bags/case	approx. case wgt.
7-1/2	7-1/2 ft.	240	49 lbs.
9	9 ft.	240	55 lbs.
12	12 ft.	240	63 lbs.
25	25 ft.	120	56 lbs.

7 Snap Chain Stringer

Display your catch of the day with this popular seven snap, 40" stringer. It features single swivel construction that prevents tangles, easy to open, secure lock snaps and cadmium plating that is tough on corrosion.

NO. 7320

Packed 1 each per polybag with header card, 12 per inner box, 144 per case. Approx. case wgt. 37 lbs.

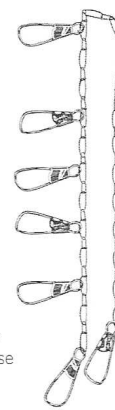

9 Snap Chain Stringer

This sturdy 46" nine snap stringer makes sure the big ones don't get away after they're caught. The single swivel construction prevents tangles, and it has easy open, secure-lock snaps and corrosion-resistant cadmium plating.

NO. 9320

Packed 1 each per polybag with header card, 12 per inner box, 144 per case. Approx. case wgt. 44 lbs.



Swivel Snap Chain Stringer

Tangling and twisting are virtually eliminated with this 48" chain stringer with nine swiveling snaps. The chain and snaps are cadmium plated to protect against corrosion.

NO. 4212

Packed 1 each per polybag with header card, 12 per inner box, 144 per case. Approx. case wgt. 51 lbs.

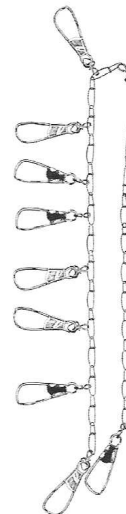

Sliding Snap Chain Stringer

This 60" cadmium plated chain stringer features nine heavy-duty snaps. One is an end snap and the other eight easily slide over the threading needle and onto the chain. Sliding sleeve snaps allow you to work with one snap at a time, without picking up the whole stringer.

NO. 4100

Packed 1 each per polybag with header card, 12 per inner box, 72 per case. Approx. case wgt. 42 lbs.

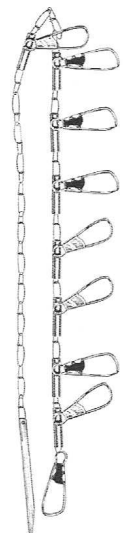

Silent Stringer

This 108" silent stringer does not make the fish spooking noises that most chain stringers cause when they rub against the side of the boat. It is constructed of a heavy-duty, twisted polycord and has 11 nylon safety lock snaps.

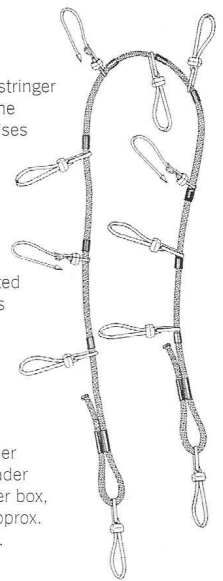

NO. 4200

Packed 1 each per polybag with header card, 12 per inner box, 144 per case. Approx. case wgt. 38 lbs.

Sliding Snap Cable Stringer

Free turning crane swivels virtually eliminate tangling and twisting with this 10 snap stringer. Brass sleeves allow the easy open, secure lock snaps to glide along a 72" vinyl-coated steel cable—all with minimal noise. An end snap is permanently looped to the cable and a large split ring at the other end guarantees a secure hook-up.

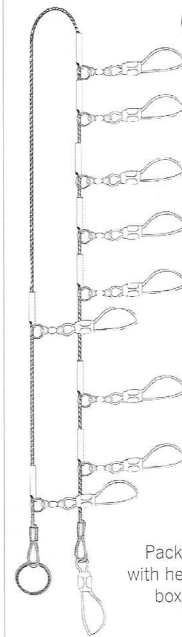

NO. S2793

Packed 1 each per vinyl bag with header card, 12 per inner box, 120 per case. Approx. case wgt. 64 lbs.

Deluxe Brass Chain Stringer

This deluxe chain stringer features a strong 72" brass chain encased in a clear vinyl tubing that minimizes noise. This tangle-free stringer comes complete with 10 safety lock swiveling snaps which are chrome-plated to resist corrosion.

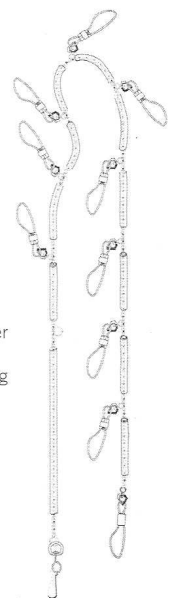

NO. 1150

Packed 1 each per vinyl bag with header card, 12 per inner box, 72 per case. Approx. case wgt. 44 lbs.



Canvas Creel

Fish can be conveniently stored and carried with this top-quality 14-1/2" x 9" fabric creel with vinyl lining. Features include an adjustable shoulder strap, two snap-closure compartments, nylon mesh side vents and a convenient silk screened ruler.

NO. 8381

Packed 1 each per polybag with hang tag, 50 per case. Approx. case wgt. 29 lbs.

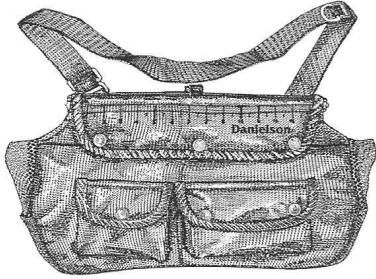

Jumbo Canvas Creel

Take the big one home in this large 19" x 12" fabric creel. It features a vinyl interior, two snap-closure compartments for extra storage, nylon mesh side vents and a silk-screened ruler.

NO. G20

Packed 1 each per polybag with hang tag, 24 per case. Approx. case wgt. 22 lbs.

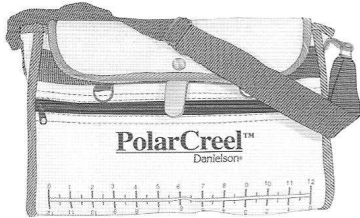

Polar Creel

Occasionally soaking this canvas Polar Creel will allow evaporation to keep fish cool and fresh. Both creel pouch and zippered pocket feature a pull-out vinyl liner for easy cleaning. A protective apron keeps the wearer dry. Measures 14" x 9".

NO. PC200

Packed 1 each per polybag with hang tag, 25 per case. Approx. case wgt. 19 lbs.

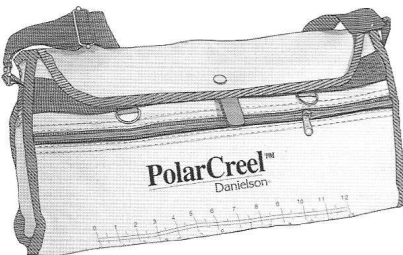

Jumbo Polar Creel

Evaporation will keep fish cool and fresh when you occasionally soak this jumbo size Polar Creel. Both creel and zippered pocket feature a pullout vinyl liner for easy cleaning. A protective apron keeps the wearer dry. Measures 18" x 9".

NO. PC300

Packed 1 each per polybag with hang tag, 25 per case. Approx. case wgt. 24 lbs.

Classic 15" Rattan Creel

Woven wicker construction allows necessary air ventilation for keeping fish cool and fresh. Measuring 15" this creel features synthetic leather trim, carry handle and printed ruler. Harness not included.

NO. 8315

Packed 1 each with hang tag, 6 per case. Approx. case wgt. 10 lbs.



Classic 18" Rattan Creel with Tackle Pouch

Woven wicker construction allows necessary ventilation for keeping fish cool and fresh. Measuring 18" this creel features handy tackle pouch on front, synthetic leather trim, carry handle and printed ruler. Harness not included.



NO. 8318

Packed 1 each with hang tag, 6 per case. Approx. case wgt. 12 lbs.

Commercial Fish Bag

This is the same bag used by charter boats for storing large fish on ice with minimal blood and slime transfer. Measuring 18" x 40" this tough 4-mil polybag is ideal for transporting fish from boat to home.

NO. FB882

Packed 250 per case. Approx. case wgt. 48 lbs.

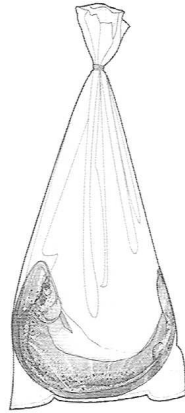

Wall-Mount Boot Hanger

Prevent mildew, cracks and creases while increasing the life span of waders and packs by properly storing them with this wall mounted boot hanger. Constructed of a durable steel wire design.

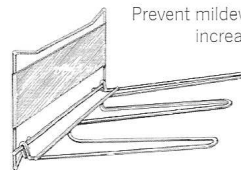

NO. 580

Packed 1 each per peg-boardable sleeve card, 12 per inner box, 72 per case. Approx. case wgt. 43 lbs.

Boot Hanger

The steel wire design of this boot hanger aids in drying boots and waders, and helps prevent mildew, cracks and creases. Absorbs weight of boots and saves space.

NO. 580S

Packed 1 each per peg-boardable sleeve card, 12 per inner box, 144 per case. Approx. case wgt. 34 lbs.

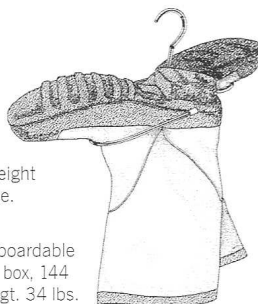

Creel Harness

Made of synthetic leather, this harness has a 2" x 18" shoulder strap, and creel and waist straps. Designed for use with rattan or split willow creels, it has solid brass hardware.

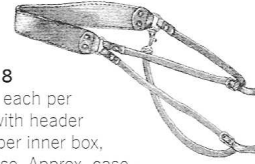

NO. CH18

Packed 1 each per polybag with header card, 12 per inner box, 72 per case. Approx. case wgt. 31 lbs.

Y-Back Wader Suspender

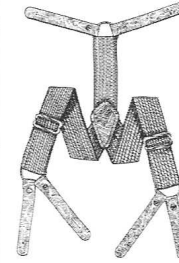

This premium quality, Y-back wader suspender features an elastic back strap and fully adjustable 1-1/2" shoulder straps for a comfortable fit. Straps are double reinforced where joined and equipped with two synthetic leather clasps attached to a rust resistant "D" ring. One size fits all.

NO. WDS

Packed 1 each per polybag with header card, 12 per inner box, 144 per case. Approx. case wgt. 47 lbs.

H-Back Wader Suspender

Specifically designed for the serious outdoorsman, this wader suspender features H-back swing-free construction and 2" straps for maximum comfort. Non-glare black plastic slides, snap off front tabs, and synthetic leather loops make this suspender perfect for fishing and hunting. Adjusts up to 32" long.

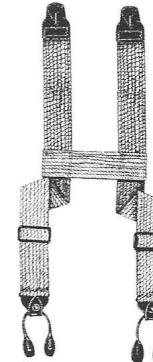

NO. WSDSLX

Packed 1 each per polybag with header card, 12 per inner box, 144 per case. Approx. case wgt. 74 lbs.

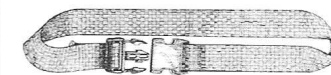

Wader Belt

Designed to provide outstanding support and comfort, this deluxe wader and bait box belt features a quick release buckle made of black, non-reflective plastic. Constructed of heavy-duty 1-1/4" webbing, this belt adjusts up to 50" in length.

NO. WDSB

Packed 1 each per polybag with header card, 12 per inner box, 144 per case. Approx. case wgt. 23 lbs.

Polarized Sportsman's Glasses

These sportsman's glasses protect eyes by polarizing unwanted glare. They feature tinted plastic lenses and an elastic lanyard. Available with smoke lenses for all-purpose use, or amber lenses for cloudy and foggy days.

code	frame color	lens color
A	black	amber
S	black	smoke



NO. 24161

Packed 1 pair per polybag with hang tag, 12 pair per inner box, 300 per case. Approx. case wgt. 34 lbs.

Pin-On License Holder

This pin-on license holder puts your fishing or hunting license just where you need it. Made of soft, pliable, clear vinyl, it measures 4-1/4" x 3-1/8" and attaches with a brass safety pin.

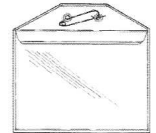

NO. LHPO

Packed 1 each per polybag with header card, 12 per inner box, 240 per case. Approx. case wgt. 14 lbs.

Retractable Accessory Reel

This clip-on accessory reel attaches to vest or shirt for easy access to line clippers, forceps, hook hone and other selected tools. A connecting clip secures equipment to a strong retractable nylon cord for convenient out of the way storage.



NO. RCR

Packed 1 each per blister card, 12 per inner box, 288 per case. Approx. case wgt. 20 lbs.

Emergency Poncho

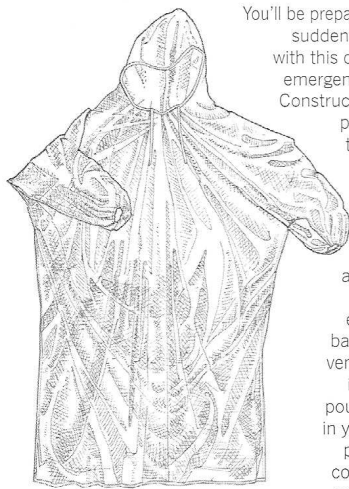

You'll be prepared for that sudden down-pour with this comfortable emergency poncho. Constructed of clear polyethylene to keep bad weather out, this poncho features a drawstring hood and elastic wrist bands. It conveniently folds into a small pouch to store in your pocket, purse, glove compartment or back pack.

NO. RWP

Packed 1 each per polybag with insert label, 40 per inner box, 240 per case. Approx. case wgt. 52 lbs.

Mosquito Head Net

The fine mesh netting of this mosquito head net keeps out the smallest insects without obstructing vision. Made with a cool cotton hat style top and neck back it features formed hat and shoulder rings to keep mesh away from face and neck. Includes adjustable headband and drawstring neck.

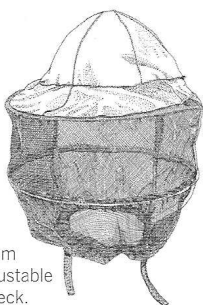

NO. MHN

Packed 1 each per polybag with wrap-around label, 12 per inner box, 72 per case. Approx. case wgt. 26 lbs.

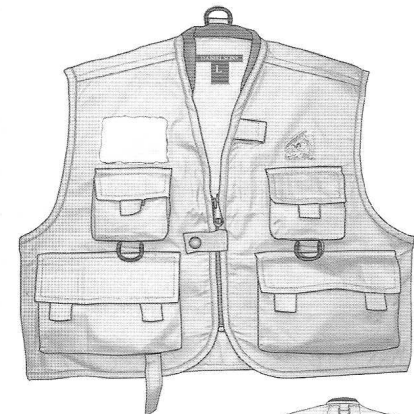

Calm Water Vest

Excellent vest for your son or daughter who wants to fish with mom or dad. With functional 5-pocket design this handsome youth vest is a superb value. Made of high performance cotton with 4 Velcro® closure front pockets and a large easy-open back pouch for storing gear and tackle. This starter vest also features an embroidered Danielson® logo, landing net D-ring, 2 front accessory D-rings, a fly patch and fleece collar. Stylish grey color.

NO. 6707

Packed 1 each per polybag with sewn-in label and hang tag, 24 per size per case.

6707 Specifications			
size	S	M	L
chest	38"	40"	42"
shoulder	14"	15"	15"
length	19"	20"	21"
case wgt.	13 lbs.	14 lbs.	15 lbs.



Classic Vest

Designed with abundant storage to keep everything you need at your fingertips, this traditional cotton vest has 4 large zippered gear pouches and 7 additional front pockets with Velcro® closures. The large easy to open back pouch, 4 Velcro® pockets, and 2 inside, zippered pockets give you all the room you need to store your gear and tackle. Additionally the Classic comes with a zippered inside cell phone pocket and pen holder. A handy rod holder loop, landing net D-ring, 2 front accessory D-rings, fly patch, and fleece collar are added bonuses. Stylish sage grey color.

NO. 6705

Packed 1 each per polybag with sewn-in label and hang tag, 24 per size per case.

6705 Specifications						
size	S	M	L	XL	XXL	XXXL
chest	43"	45"	48"	50"	53"	56"
shoulder	15"	15.5"	16.75"	18"	19.25"	20.5"
length	21"	22"	23"	24"	24.5"	25"
case wgt.	26 lbs.	27 lbs.	29 lbs.	31 lbs.	32 lbs.	33 lbs.



Easy Breather Vest

The nylon mesh shoulders, chest and back of this terrific vest are made to keep you cool. Designed to be comfortable and practical, this 13-pocket vest is perfect for fishing in warm weather. This vest has 2 large, zippered gear pouches, 6 additional front pockets with Velcro® closures to keep your gear secure, a large back pouch and 2 inside pockets with Velcro® closures. A handy rod holder loop, 2 heavy duty D-rings for landing net or tools and 2 fly patches are added bonuses. Stylish sage grey color.

NO. 6703

Packed 1 each per polybag with sewn-in label and hang tag, 24 per size per case.

6703 Specifications						
size	S	M	L	XL	XXL	XXXL
chest	43"	45"	48"	50"	53"	56"
shoulder	17"	17.75"	19"	20.25"	21.5"	22.75"
length	21"	22"	23"	24"	24.5"	25"
case wgt.	18 lbs.	19 lbs.	20 lbs.	21 lbs.	22 lbs.	23 lbs.



Ultimate Vest

Made of highly durable rip-stop nylon, this exclusive vest provides abundant storage and unique new features which include: 21 pockets, dual coil accessory retractor, rod holder loop, heavy duty landing net and accessory D-rings, and a fleece and neoprene collar. Added features include grommets built into the inside pockets for easy access to yarn and leaders, cell phone and pen pocket, and a specially designed vest back that folds into a pocket converting it into a mesh vest on warm, dry days, providing maximum comfort with excellent functionality.

NO. 6709

Packed 1 each per polybag with sewn-in label and hang tag, 24 per size per case.

6709 Specifications						
size	S	M	L	XL	XXL	XXXL
chest	43"	45"	48"	50"	53"	56"
shoulder	15"	15.5"	16.75"	18"	19.25"	21.5"
length	21"	22"	23"	24"	24.5"	25"
case wgt.	25 lbs.	27 lbs.	28 lbs.	29 lbs.	31 lbs.	32 lbs.



Cascade Vest

This exclusive, heavyweight cotton canvas vest is jumbo cut to be worn over winter outerwear. Features include a soft fleece upper collar for comfort and warmth and lower neoprene collar to reduced neck fatigue. With 12 front pockets, 10 inside pockets and 2 large pouches on the back, the Cascade has more than enough storage space for gear and tackle. Additional features include cell phone and pen holders, snap-lock plier sleeve, dual coil accessory retractor, rod holder loop, landing net and accessory D-rings and grommets on 6 inside pockets for easy access to yarn and leaders. Carhartt® brown with black trim.

NO. 6717

Packed 1 each per polybag with sewn-in label and hang tag, 24 per size per case.

6717 Specifications						
size	S	M	L	XL	XXL	XXXL
chest	46"	48"	52"	54"	57"	60"
shoulder	16.25"	16.75"	18"	19.25"	20.5"	21.5"
length	23"	23"	24"	25"	26"	26.5"
case wgt.	50 lbs.	52 lbs.	55 lbs.	59 lbs.	62 lbs.	63 lbs.

Sectional Bamboo Poles

These stain varnished sectional bamboo poles have been fire-hardened for strength with joint membranes punctured to prevent cracking and splitting. Features include chrome-plated slip ferrules.

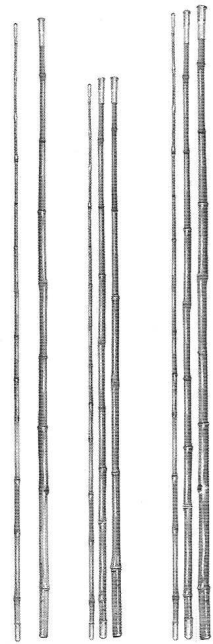

NO. PBJ

Packed 1 pole shrink-wrapped with header card.

code	length	sections	pcs./case	approx. case wt.
102	10'	2	24	9 lbs.
123	12'	3	12	8 lbs.
143	14'	3	12	11 lbs.

Rigged Sectional Bamboo Poles

Rigged with monofilament line, hook, sinker and float on a winder, these stain varnished sectional bamboo poles are ready to fish. Fire-hardened for strength with joint membranes punctured to prevent cracking and splitting. Features include chrome-plated slip ferrules.

NO. PBJR

Packed 1 pole shrink-wrapped with header card.



PBJR102 PBJR123

code	length	sections	pcs./case	approx. case wt.
102	10'	2	24	11 lbs.
123	12'	3	12	10 lbs.

Emergency Rod Tip Repair Kit

This kit is made for on-the-spot repairs of broken rod tips. It includes a replacement top, an expansion spring to compensate for the variations in rod blank diameters and heat applied shrink tubing to secure the new rod top.

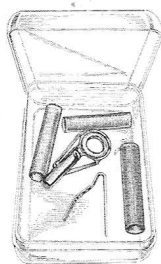

NO. RTRK

Packed 1 kit per blister card, 24 cards per inner box, 480 per case. Approx. case wt. 24 lbs.

Rod Tip Replacement Kit

Worn and damaged rod tip tops can quickly and easily be replaced with this replacement kit which includes 2 tip tops in sizes 6 and 7 and an instant setting hot melt glue stick. Featuring an aluminum oxide inner ring and stainless steel frame, these durable tip tops guarantee smooth casting and minimal line wear.

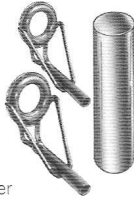

NO. RTK

Packed 1 kit per blister card, 12 cards per inner box, 480 per case. Approx. case wt. 21 lbs.

Hot Melt Glue Stick

This hot melt glue stick is perfect for repairing, replacing or upgrading tip tops quickly and easily. Apply heat to the tube of the tip top being replaced, then remove it. Heat the tube of the replacement tip top then melt the hot glue onto rod tip and immediately slide on and align with guides. Glue sets in 3 or 4 seconds.



NO. GS

Packed 2 sticks per blister card, 12 cards per inner box, 480 per case. Approx. case wt. 19 lbs.

Rod Tops

These spinning and casting rod tops feature an aluminum oxide inner ring that is made super hard for wear and super smooth for near friction free casting and minimized line wear. Constructed with stainless steel frames, they are the perfect answer for replacing, repairing and upgrading rod tip tops.



NO. TT

Packed 1 each per blister card, 10 cards per inner box, 120 per case. Approx. case wt. 3 lbs.

code	tube inside dia.	ring outside dia.
5	5/64"	5 mm
5.5	11/128"	5 mm
6	3/32"	5 mm
7	7/64"	5 mm
8	1/8"	6.5 mm

Furnished Line

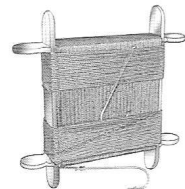

This ready to use braided line is 70 feet in length and features two size 4 hooks and a sinker conveniently wrapped on a durable plastic winder.

NO. 19W

Packed 1 each per polybag with header card, 24 per inner box, 288 per case. Approx. case wt. 19 lbs.

Trot Lines

Made of the finest nylon line, these trot lines are equipped with hard tempered, double strength, needle sharp hooks staged every 12 inches. Swiveled trot lines feature corrosion-resistant brass retainers to prevent slipping. Convenient winding spool allows leaders to be attached quickly.

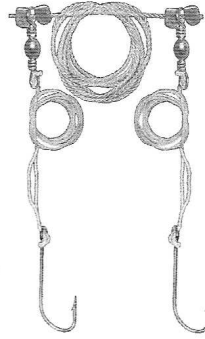

NO. TL

Packed 1 each per polybag with header card, 12 per inner box, 48 per case.

code	lb. lgt.	test	hook hks.	swivel size	approx. case wt.
2020	100'	210	20	2/0 n/a	15 lbs.
2040	100'	210	20	4/0 #1	24 lbs.
2540	150'	300	25	4/0 #1	28 lbs.

Marker Buoy

This "H" shaped molded plastic buoy makes marking locations quick and efficient. Simply release the marker buoy, and the 6 oz. lead weight automatically unspools the nylon cord up to 75 feet to mark and hold the desired position.

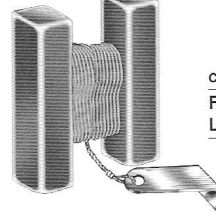

Available in fluorescent red for day use and luminescent green for night use.

code	color
FR	fluor. red
LG	lum. green

NO. MB

Packed 2 per polybag with header card, 12 bags per inner box, 24 per case. Approx. case wt. 29 lbs.

Jug Buoy

Ideal for jug lines and trot lines the Jug Buoy features a molded handle with line wrap and a recessed line connector. Finished in fluorescent orange for day or night use it works great anywhere a buoy or marker is required..

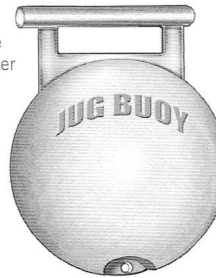

NO. JBUOY

Packed 1 each with fold-over header card, 12 per case. Approx. case wt. 6 lbs.

Clamp-On Fishing Bell

Made of copper-plated steel, this fishing bell has an easy to use, spring-loaded clip that attaches to the rod tip. The bell rings loudly when the fish grabs the bait.



NO. BWC

Packed 1 each per polybag with header card, 12 per inner box, 432 per case. Approx. case wt. 23 lbs.

NO. BWC25BULK

Bulk packed 25 each in a polybag, 1,000 per case. Approx. case wt. 33 lbs.

Fishing Bells with Luminous Clip

These state-of-the-art fishing bells were designed for night fishing and have a rod clip that glows in the dark. Easily recharged from any flashlight, the adjustable "V" groove clip is made to fit most rod tips.

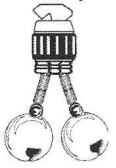

NO. BWCL

Packed 1 each per polybag with header card, 12 per inner box, 240 per case. Approx. case wt. 8 lbs.

Clamp-On Fishing Bells

This unique fish alarm is super sensitive and features two spring-mounted round bells designed to ring the moment a fish picks up the bait. Complete with easy to use sure-grip clip; just squeeze the lever to place on and take off.



NO. BWCLD

Packed 1 each per polybag with header card, 12 per inner box, 240 per case. Approx. case wt. 9 lbs.

Clamp-On Jumbo Bell

This easy to use, 1" round, stainless steel bell is spring-mounted to a sure-grip clip that attaches to the rod tip. Designed to be highly sensitive, this bell rings at the moment a fish picks up the bait.

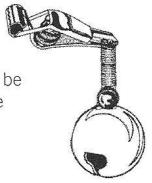

NO. BWCF

Packed 1 each per polybag with header card, 12 per inner box, 360 per case. Approx. case wt. 15 lbs.

Liberty Bell with Clip

The nickel-plated steel construction of this clamp-on fishing bell offers fishermen a superb value. Sounding loudly when the fish takes the bait, the bell has a spring-loaded clip that makes it easy to use.



NO. BWCD

Packed 1 each per polybag with header card, 12 per inner box, 240 per case. Approx. case wt. 16 lbs.

Cow Bells

Available in sizes to meet any fishing situation, these ever popular, time-tested cow bells will sound the alarm. Complete with spring steel wire clip for easy on/off attachment.



NO. BWCC

Packed 1 each per polybag with header card, 12 per inner box.

code	width	each/case	approx. case wt.
S	1-3/4"	240	23 lbs.
M	2-1/4"	120	20 lbs.
L	3-1/8"	72	26 lbs.

Portable Floor Rod Rack

This portable floor rack is perfect for displaying rods and rod and reel combinations. The system is designed to securely hold 24 rods that can be easily removed or replaced. Constructed entirely of steel and fitted with casters for easy portability. Assembly required.

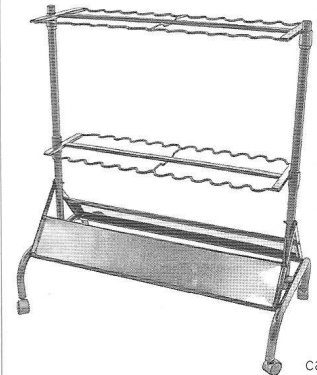

NO. RRFD

Packed 1 display per case. Approx. case wt. 20 lbs.

Vertical Rod Rack

This wall-mounted, molded plastic rack is a fast, easy and economical way to store four fishing rods with reels in an upright position. The lower rack locks rod butts in place while the high-density, grip-tight foam pads in the upper rack house rod tips securely in place.

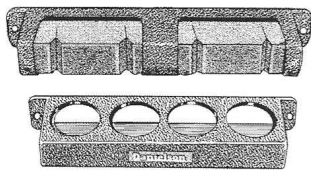

NO. 4122V

Packed 1 set per blister card, 12 sets per inner box, 36 per case. Approx. case wgt. 22 lbs.

Horizontal Rod Rack

This rack is designed to safely store four fishing rods overhead or horizontally mounted on a wall. Uniquely constructed for maximum protection, both ends of the rod are held tightly in place with high-density, grip-tight foam fitted into rugged plastic housings.

NO. 4122H

Packed 1 set per blister card, 12 sets per inner box, 36 per case. Approx. case wgt. 22 lbs.

Rod Display Rack

Showcase fishing rods and rod and reel combos of most any size and type with this 2 piece, 14 slot display rack. Rods are secured in place with a rubber double tab locking system. Measuring only 4-1/4" wide and 15-1/4" long this rack allows flexible positioning on any pegboard or slotwall fixture.

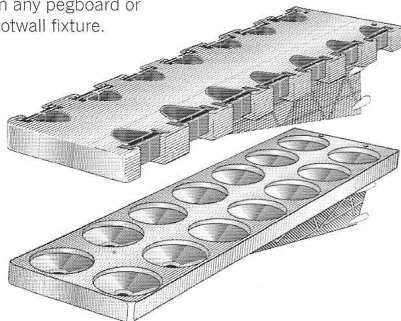

NO. RR1

Packed 1 set shrink-wrapped with insert label, 20 per case. Approx. case wgt. 37 lbs.

Reel/Rod Display Cradle Slotwall Adapter

Bracket adapts RRD Reel/Rod Display Cradle to slotwall systems. Features include a security clip for locking bracket in place.

NO. RRDWSA

Packed 1 each per polybag, 72 per case. Approx. case wgt. 39 lbs.

Rod Display Rack Slotwall Adapter

Brackets adapt RR1 Rod Display Rack to slot-wall systems. Features include security clips for locking brackets in place.

NO. RRSWA

Packed 1 pair per polybag, 36 pair per case. Approx. case wgt. 32 lbs.

Reel Seat Display Handles

Designed specifically for display, these reel seat handles allow convenient and effective presentation of fishing reels. Made for use with the reel/rod display cradle they are available in both spinning and casting models.



NO. RSDHC (casting)

NO. RSDHS (spinning)

Packed 1 each in a polybag, 24 per inner box, 144 per case. Approx. case wgt. 28 lbs.

Reel/Rod Display Cradle

Designed to display fishing reels or feature rod and reel combos. Simply mount the reel on the reel seat handle and insert into the display cradle. Designed for use with pegboard or slotwall fixtures, the cradle securely locks in place and provides space for labeling.

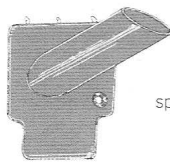

NO. RRD

Packed 1 each in a polybag, 24 per inner box, 144 per case. Approx. case wgt. 17 lbs.

Rod Stand

Keep the tip of the ice rod up and away from the ice and snow. The rod locks into an integrated rubber clip at the top of this super lightweight wire stand.



NO. IFRS

Packed 2 per polybag with header card, 12 cards per inner box, 240 per case. Approx. case wgt. 15 lbs.

Bucket Mount Rod Holder

Designed to mount onto a utility bucket this rod holder permits the rod and reel to be easily and quickly removed when a fish strikes. Constructed of wire with a tough enamel finish.

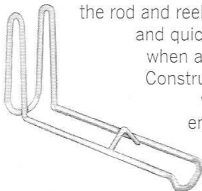

NO. IFRHB

Packed 1 each with header card, 12 cards per inner box, 240 per case. Approx. case wgt. 38 lbs.

Sand Spike Rod Holder

This versatile rod holder goes from the beach to the bank. Constructed of heavy-gauge steel, it has a 15" spike, an adjustable swivel yoke, adjustable tilt for rod angle and a 1-1/2" handle slot.

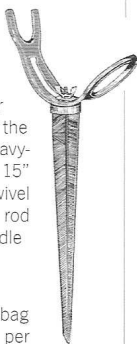

NO. 633

Packed 1 each per polybag with header card, 12 per inner box, 60 per case. Approx. case wgt. 30 lbs.

Clamp-On Rod Holder

This all-purpose rod holder goes from boat to pier and accommodates all styles of rods. Constructed of heavy-gauge steel, it has a 2-3/4" clamp, 360-degree adjustable swivel yoke, adjustable tilt for desired rod angle and a tough enamel finish that resists corrosion.

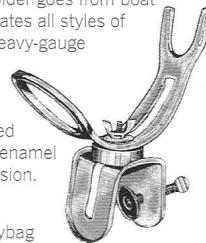

NO. 503

Packed 1 each per polybag with header card, 12 per inner box, 60 per case. Approx. case wgt. 28 lbs.

Heavy-Duty Clamp-On Rod Holder

Featuring a 360-degree adjustable swivel yoke and fully adjustable tilt, this rod holder has a full range of positions. The 1-3/4" handle slot accommodates larger fishing rods, and its 2-3/4" clamp opening allows it to mount almost anywhere. Constructed of heavy-gauge steel, a tough enamel finish fights corrosion.

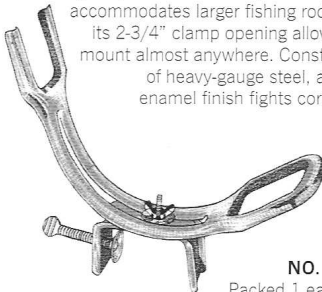

NO. 366G

Packed 1 each per polybag with header card, 12 per inner box, 36 per case. Approx. case wgt. 26 lbs.

Spike Rod Holder

Made of strong steel rod these one piece spike rod holders are simple in design and easy to use. Long bent-in foot tongue assists with inserting the spike into the ground. Finished in red enamel to resist rust and corrosion. Available in 3 sizes.

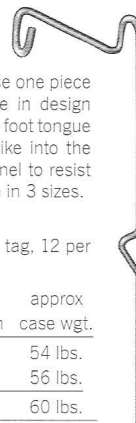

NO. RHS

Packed 1 each with fold-over tag, 12 per inner box, 72 per case.

code	steel rod dimensions	rod length	approx case wgt.
14	1/4"	21"	54 lbs.
516	5/16"	31"	56 lbs.
38	3/8"	41"	60 lbs.

Surface Rod Stand

Designed to keep rod and reel off the ice and snow. Allows quick and easy rod removal when a strike occurs. Steel wire construction finished in a high visibility red enamel finish.

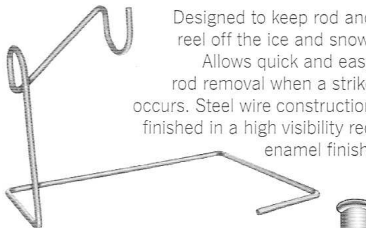

NO. IFRHS

Packed 1 each with fold-over tag, 12 per inner box, 72 per case. Approx. case wgt. 30 lbs.

Adjustable PVC Sand Spike

Made of PVC this one piece spike rod holder is simple in design and easy to use. Set screw and wing-nut adjust to accommodate most rod butt lengths.

NO. RHTPA

Packed 1 each per vinyl bag with header card, 24 per case. Approx. case wgt. 15 lbs.

Fully Adjustable Easy Drifter Rod Holder

Designed to position rods at the optimum angle this rod holder adjusts for both elevation and angle from the boat. Cradle configuration secures rod yet permits single motion hook setting and rod removal. Large swivel locking ring holds rod in place while running or trolling. Side mount is included.

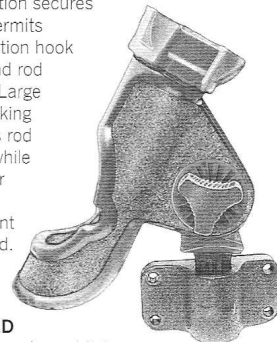

NO. RHED

Packed 1 each per blister sleeve, 6 per inner box, 24 per case. Approx. case wgt. 31 lbs.

Easy Drifter Rod Holder

Designed to allow single motion hook setting and rod removal this rugged nylon rod holder features a 12-position, 360-degree adjustable yoke.

Constructed with a fixed angle, open face tube it has a revolving retaining ring to secure the rod in place. ABS plastic side mount is provided. Rail mount adapter and flush mount are sold separately.



NO. EDRH1

Packed 1 each per blister sleeve, 6 per inner box, 24 per case. Approx. case wgt. 30 lbs.

Rail Mount Adapter

Works only in conjunction with side mount. Used with 7/8" and 1" rails. Designed for use with Easy Drifter rod holders.



NO. EDRH1RM

Packed 1 each per blister sleeve, 12 per inner box, 144 per case. Approx. case wgt. 25 lbs.

Side Mount

Used on flat, vertical surfaces, or in conjunction with a rail mount adapter. Designed for use with Easy Drifter rod holders.

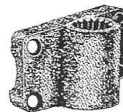

NO. EDRH1SM

Packed 1 each per blister sleeve, 12 per inner box, 144 per case. Approx. case wgt. 37 lbs.

Flush Mount

Used on flat, horizontal surfaces. Minimum mounting width required. Designed for use with Easy Drifter rod holders.

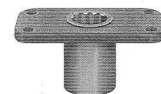

NO. EDRH1FM

Packed 1 each per blister sleeve, 12 per inner box, 144 per case. Approx. case wgt. 30 lbs.

Pocket 6 Tackle Box

Perfect for vest pocket storage of small tackle items this 6-compartment see-through box features a snap-lock closure. Measuring 4-5/8" x 2-7/8" x 1" it is made of worm-proof plastic.

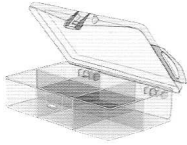

NO. BLB6

Packed 1 each skin-packed with insert label, 12 per inner box, 288 per case. Approx. case wgt. 25 lbs.

Pocket 9 Tackle Box

This 9-compartment see-through tackle box is configured to store lures and accessories and features two snap-lock closures for added security. Made of worm-proof plastic it measures 6-1/2" x 3-5/8" x 1-1/4" to easily fit in vest pocket.

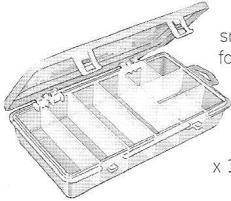

NO. BLB9

Packed 1 each skin-packed with insert label, 12 per inner box, 72 per case. Approx. case wgt. 16 lbs.

Double-Sided 16 Tackle Box

Convenient double-sided see-through design features 16-compartments in a variety of sizes and shapes for storage of tackle and accessories. Made of worm-proof plastic it measures 8-1/2" x 5" x 2-1/8" to easily fit into larger tackle boxes.

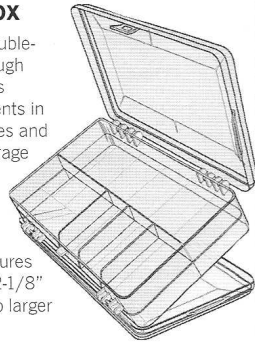

NO. BLB2X16

Packed 1 each skin-packed with insert label, 12 per inner box, 72 per case. Approx. case wgt. 27 lbs.

Beginner's Tackle Box

Perfect for the novice fisherman, this 4-compartment box has a lid that displays tying instructions for the 10 most commonly used knots. Measures 6-3/4" x 4" x 1-1/2" deep.



NO. T5452

Packed 1 each per polybag with header card, 12 per inner box, 120 per case. Approx. case wgt. 30 lbs.

Stack Pack Jars

Made of tough transparent plastic, these stack pack jars are ideal for storing flies, lures, hooks, sinkers, and other small tackle. These space-saving jars screw together for easy selection and convenient storage.

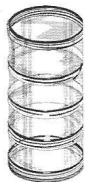

NO. PT

Packed 1 set per polybag with header card.

code	jar dia.	jar depth	jar sets	jars/sets	sets/ approx. case	case wgt.
4	2-1/2"	1-1/4"	4	12	144	35 lbs.
5	2"	1-1/4"	5	36	216	48 lbs.
6	1-5/8"	7/8"	6	48	288	38 lbs.

Pocket Fly Box

Constructed of ABS plastic this double-sided fly box with snap-lock lids features both flat and ripple closed-cell foam liners. Measuring 4-1/2" x 3-1/2" x 1-3/8" it easily fits into vest pocket. Stays afloat if dropped.



NO. BHFB5

Packed 1 each per polybag with header card, 12 per inner box, 144 per case. Approx. case wgt. 41 lbs.

Vest Fly Box

Constructed of ABS plastic, this double-sided fly box with snap-lock lids features both flat and ripple closed-cell foam liners. Measuring 7" x 4-1/2" x 1-1/2", it easily fits into vest or tackle box. Stays afloat if dropped.

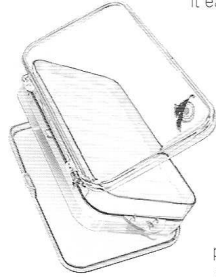

NO. BHFB1

Packed 1 each per polybag with header card, 6 per inner box, 72 per case. Approx. case wgt. 37 lbs.

Dial Fly Box

This 6-compartment plastic fly box features a cork-lined bottom, transparent lid and a snap for vest attachment. Measuring 4-3/4" in diameter simply dial the lid to open the desired compartment.



NO. 216

Packed 1 each per polybag with header card, 12 per inner box, 120 per case. Approx. case wgt. 32 lbs.

Flip-Over Bait Box

Simply flip-over the upside down box to find and retrieve bait from what is now the top. The large capacity aluminum bait box reflects heat and will not rust. Features include a curved steel belt housing for fit and comfort and a lock-open for convenience.

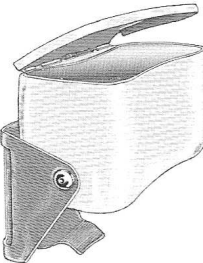

NO. BBFO

Packed 1 each per polybag with header card, 12 per inner box, 144 per case. Approx. case wgt. 56 lbs.

Bait Box

This molded plastic bait box features 2-compartments and hinged lid for easy bait access. Belt-attached for convenience, it's contoured for comfort and fit.

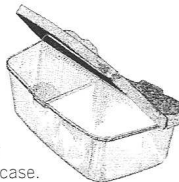

NO. M5

Packed 1 each per polybag with header card, 12 per inner box, 144 per case. Approx. case wgt. 26 lbs.

Clip-On Revolving Bait Can

This exclusive revolving bait can positions the lid to the bottom for bait storage. Simply rotate the cylinder to retrieve bait that naturally works its way to the bottom of the container. In addition to a snap lock closure the design incorporates cylinder shrouds to ensure the lid remains closed until properly positioned for opening.

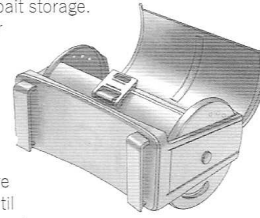

Contoured for comfort and fit the bait can's clip-on feature allows it to be attached and removed quickly and easily. Cylinder measure 2-5/8" in diameter by 4-3/4" long. All plastic construction is easy to clean.

NO. DBC

Packed 1 each skin-packed with insert label, 12 per inner box, 72 per case. Approx. case wgt. 18 lbs.

Clip-On Bait Box

This exclusive 2-compartment bait box is designed with a fold-out lid that serves as a tray. Clip-on feature allows bait box to be attached and removed quickly and easily while snap lock closure ensures lid remains closed until bait is needed. Contoured for comfort and fit the bait box measures 6" x 2-3/4" x 2-1/4" high. All plastic construction is easy to clean.

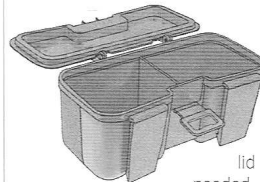

NO. DBB

Packed 1 each skin-packed with insert label, 6 per inner box, 72 per case. Approx. case wgt. 26 lbs.

Jumbo Bait Box

Ventilated to keep bait cool and fresh this large capacity, molded plastic bait box features a sturdy snap-latch cover, which removes for easy cleaning. Belt-attached for convenience, it is contoured for comfort and fit.

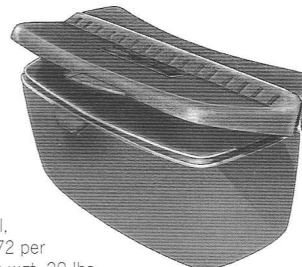

NO. Y568

Packed 1 each shrink-wrapped with label, 12 per inner box, 72 per case. Approx. case wgt. 29 lbs.

Clip-On Bait Tub

This exclusive 2, 3 or 4-compartment bait tub is designed for steelhead and salmon fishermen. Super-sized at 10" x 3-1/4" x 3-3/4" each half has a separate lid with snap lock closure to ensure they remain closed until bait is needed. Contoured for comfort and fit the bait tub's clip-on feature allows it to be attached and removed quickly and easily. Snap-off lid unit and all plastic construction permit easy cleaning.

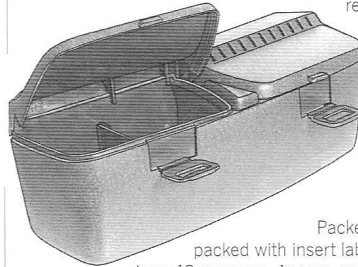

NO. DBT

Packed 1 each skin-packed with insert label, 6 per inner box, 48 per case. Approx. case wgt. 25 lbs.

Leader Pouch

Keep leaders and rigs at the ready with this convenient 16-sleeve wallet with fold-over, snap-closure cover. Measures 3-3/4" x 3-3/4".

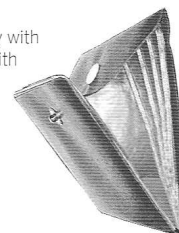

NO. LP1

Packed 1 each per polybag with header card, 24 cards per inner box, 288 per case. Approx. case wgt. 31 lbs.

Worm Threader

Worm threader application gives bait a natural, animated action so you'll catch more fish. Threading saves time and bait because baits are more secure. Features include a swivel snap for attachment and a foam handle that floats tool for easy retrieval.

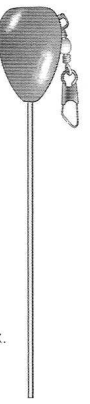

NO. TDRW

Packed 1 each per blister card, 12 cards per inner box, 240 per case. Approx. case wgt. 22 lbs.

Bait Threader

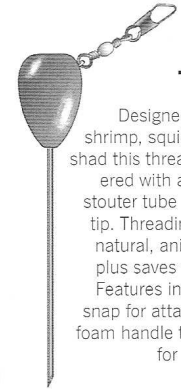

Designed for baits like shrimp, squid, herring and shad this threader is engineered with a stronger and stouter tube and a pointed tip. Threading gives bait a natural, animated action; plus saves time and bait. Features include a swivel snap for attachment and a foam handle that floats tool for easy retrieval.

NO. TDRB

Packed 1 each per blister card, 12 cards per inner box, 240 per case. Approx. case wgt. 22 lbs.

Bait Maker

Syringe design makes perfect dough bait plugs without touching the bait. Oversized finger loop and T-grip allow for single hand operation.



NO. DBM

Packed 1 each per blister card, 24 cards per inner box, 240 per case. Approx. case wgt. 13 lbs.

Worm Blower



Keep your worm off the bottom of the lake and out of the weeds with the easy to use Worm Blower. Simply inject air into the worm and increase the size and visibility of your worm.

NO. WB

Packed 1 set per blister card, 12 sets per inner box, 144 per case. Approx. case wgt. 5 lbs.

Snelled Hook Holder

Keep snelled hooks tangle-free with this 11" sturdy plastic hook holder. Spring-action storage allows you to store up to 20 hooks with leaders of any length.



NO. 400

Packed 1 each per polybag with header card, 12 cards per inner box, 144 per case. Approx. case wgt. 36 lbs.

Boat Knife and Pliers Holder

Designed for boats this tool holder provides quick and easy access to knives and pliers. Featuring three knife slots and three pliers slots this rugged holder is made entirely of plastic and engineered strong with recessed mounting channels. Mounting hardware not included.

NO. HBKP

Packed 1 each per polybag with header card, 12 per inner box, 72 per case. Approx. case wtg. 12 lbs.

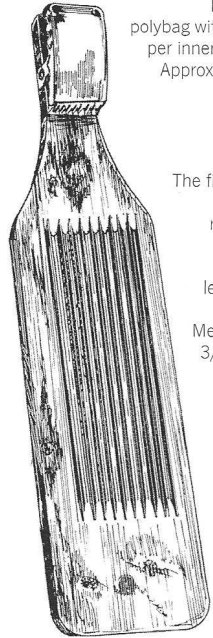

Fillet Board

The fillet board's ribbed grooves and rust resistant, deep jaw steel clamp firmly holds your catch, letting you use your hands for filleting. Measuring 24" x 6" x 3/4", this hardwood board cleans up easily.

NO. FB246

Packed 1 each skin-packed with insert label, 12 per case. Approx. case wtg. 32 lbs.

Pocket Screwdriver Set

This set contains six precision screwdrivers with standard and Phillips head blades. Packaged in a durable plastic case, this set is great to have in a tackle box for in-the-field repairs.

NO. TK106

Packed 1 set per blister card, 20 per inner box, 120 per case. Approx. case wtg. 38 lbs.

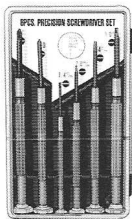

Pocket Tool Kit

This handy sportsman's kit includes: plastic handle with universal chuck, conventional blade screwdriver, Phillips screwdriver, awl and small crescent wrench conveniently packaged in a vinyl case.

NO. TK308

Packed 1 kit per blister card, 24 per inner box, 288 per case. Approx. case wtg. 35 lbs.



Fisherman's Kit

Four essential fisherman's tools are packaged together in this money saving kit: stringer, knife, scaler and hook remover.

NO. 6150

Packed 1 kit per blister card, 12 per inner box, 120 per case. Approx. case wtg. 40 lbs.

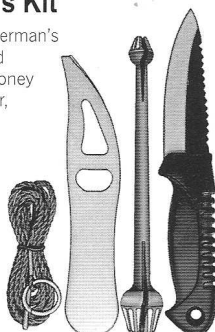

Bait Knife

This finely crafted bait knife is a must in every fisherman's tackle box. It has a 3-3/8" stainless steel blade and plastic handle. The top side of the blade has a saw tooth edge for cutting bones and cartilage. The sharpened edge is great for cleaning and scaling fish and cutting bait.

NO. BK350

Packed 1 each per polybag with insert card, 12 per inner box, 120 per case. Approx. case wtg. 14 lbs.

NO. BK350BULK

Bulk packed 12 each per inner box, 240 per case. Approx. case wtg. 21 lbs.



Bait Cutting Board

Strong, durable, and a snap to clean, this bait cutting board has a fry pan style handle with a die cut hole that makes it easy to store. Made of tough polyethylene, it measures 7" x 14" and is 1/2" thick.

NO. CBRD

Individually shrink-wrapped with insert label, 12 per inner box, 36 per case. Approx. case wtg. 45 lbs.

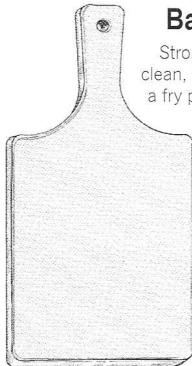

Bait Cutting Guide

This durable plastic guide provides two cut plug angles to ensure your bait has the rolling action fish can't resist.

NO. BCG1

Packed 1 each per polybag with header card, 12 per inner box, 144 per case. Approx. case wtg. 25 lbs.

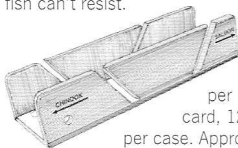

Premier Oyster Knife

Fitting precisely in your hand, this oyster knife is designed specifically for opening the shell and removing the delectable oyster. This classic knife is made with a tempered stainless steel blade that is available in two lengths. Handle has a molded thumb guard and is slip-resistant.

Packed 1 each per skin-pack card, 12 per inner box, 120 per case.

NO.	blade length	approx. case wtg.
OK2625R	2-5/8"	29 lbs.
OK375R	3-3/4"	30 lbs.



Oyster Knife with Guard

Especially engineered for a tight grip, this superb shucking knife has a 360-degree guard for added safety. And the contoured wooden handle of this knife won't slip out of your hand. This heavy-duty oyster knife has a 3-1/2" tempered stainless steel blade.

NO. 4018AHD

Packed 1 each per blister card, 12 per inner box, 120 per case. Approx. case wtg. 24 lbs.



Oyster Knife

This affordable oyster knife is made for shucking. The tight-grip wooden handle resists slipping, and the 3" stainless steel blade gets the job done safely.

NO. 4018A

Packed 1 each per blister card, 12 per inner box, 144 per case. Approx. case wtg. 21 lbs.

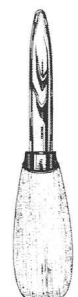

Pin Bone Knife with Sharpening Steel

Designed to remove the pin bones of most fish this patented knife is quick and easy to use. With skin side of fillet down, draw blade back toward the tail along the row of pin bones. Hidden pin bones and surrounding flesh are removed in a single cut. Unique stainless steel blade and engineered plastic handle are easy to clean and maintain. Sharpening steel and blade cover are included.

NO. PNBNR

Packed 1 each per clam-pack, 12 per inner box, 144 per case. Approx. case wtg. 46 lbs.

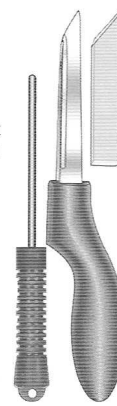

Premium Fillet Knife with Sheath

Designed and engineered for filleting fish this knife is constructed with a super sharp 6" stainless steel blade and a non-slip, ergonomically correct handle. Features include full tang construction for superior strength and a reinforced oxford nylon sheath with built in plastic insert to secure blade tip.

NO. FK6P

Packed 1 each per clam-pack with insert label, 12 per inner box, 72 per case. Approx. case wtg. 26 lbs.

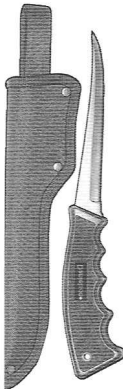

Floating Fillet Knife with Sheath

One of the most popular knives available today! Not only does this fillet knife combine value and superb quality, but it floats. It has an ultra-sharp, 6" tempered stainless steel blade and a hollow cavity handle with removable cap. It comes complete with an attractive clip-on plastic sheath.

NO. FK6F

Packed 1 each per skin-pack card, 12 per inner box, 120 per case. Approx. case wtg. 35 lbs.

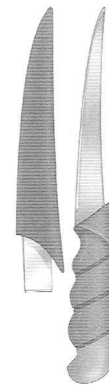

Fillet Knife with Sheath

This razor sharp knife makes filleting easy. The tempered 6-1/4" stainless steel blade has just the right flex to make short work of filleting. This knife features a sure-grip wooden handle and plastic sheath with belt loop.

NO. FK6W

Packed 1 each per blister card, 12 per inner box, 60 per case. Approx. case wtg. 19 lbs.

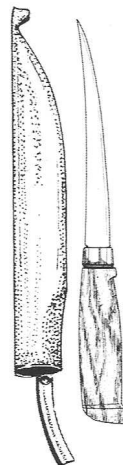

Spoon Knife

This ultra-sharp knife has just the right flex for smooth precision filleting. And with a spoon molded to the handle, it permits quick and complete evisceration of salmon and big trout. Features include a 6-1/2" tempered stainless steel fillet blade and a finely crafted handle that resists slipping, even when wet.

NO. GK6R

Packed 1 each per skin-pack card, 12 per inner box, 120 per case. Approx. case wtg. 45 lbs.



Sharpening Steel w/Rubber Handle

Designed for fishermen, this multi-surface, diamond dust impregnated sharpening steel features both round and flat surfaces and a grooved slot for sharpening hooks.

NO. SSRH

Packed 1 each per clam-pack with insert label, 12 per inner box, 144 per case. Approx. case wtg. 10 lbs.



Hook Point File

Put the bite back in your favorite hooks with this superb, light-weight file. Made of high-carbon steel, this file has an ultra fine cutting edge that makes hooks razor sharp in seconds. Measuring 3/8" x 5-1/4", it has a tapered, round plastic handle for a comfortable, sure grip.

NO. HPF

Packed 1 each per skin-pack card, 12 per inner box, 300 per case. Approx. case wtg. 12 lbs.



Hook File with Handle

Every fisherman knows a sharp hook can be the difference between catching and losing a trophy fish! This top of the line 3" file is constructed of high-carbon steel and has an easy to grip 3" plastic handle.

NO. HF1

Packed 1 each per blister card, 12 per inner box, 120 per case. Approx. case wtg. 21 lbs.



Hook File

The superior quality of this file makes a point for better hooked fish. Made of high-carbon steel, this ultra-fine hook file measures 3/4" x 5-1/2". It is small enough to slip into a vest pocket. Treating the file with a silicone lubricant helps to prevent corrosion.

NO. HF2

Packed 1 each per blister card, 12 per inner box, 120 per case. Approx. case wtg. 13 lbs.



Hook Hone

The slotted design of this fine-grain hard stone, hones and polishes hooks to a razor sharp point. Its flat reverse side touches up knives quickly. This pocket size stone measures 3-1/8" long x 7/8" wide x 3/8" thick.

NO. HH25

Packed 1 each per blister card, 12 per inner box, 240 per case. Approx. case wtg. 23 lbs.

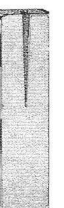

Line Clipper

The handiest tool a fisherman can own! This great item has a clipper, knife, disgorging, stiletto and a lanyard that conveniently attaches to a vest.



NO. 71

Packed 1 each per blister card, 12 per inner box, 120 per case. Approx. case wgt. 12 lbs.

Jumbo Line Clipper

This clipper is great for any tackle box or vest pocket.

It features a knife, disgorging, stiletto, bottle opener and screwdriver blade.

A convenient lanyard makes it easy to use while it's attached to a vest.

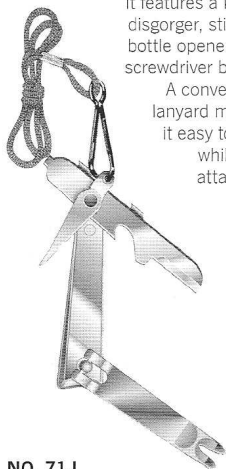

NO. 71J

Packed 1 each per blister card, 12 per inner box, 120 per case. Approx. case wgt. 19 lbs.

Line Cutter with Spike

This stainless spring steel tweezers-type nipper is designed for cutting and trimming fishing line. Features include a recessed spike and a hole for attaching a lanyard.



NO. LCWS

Packed 1 each per blister card, 12 cards per inner box, 288 per case. Approx. case wgt. 14 lbs.

Braided Line Cutter

Designed to easily cut braided lines this tweezers-type nipper is made of strong, lightweight plastic with a razor sharp stainless steel blade. Safe and easy to use this cutter features a hole for attaching a lanyard.

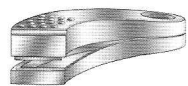

NO. LCB

Packed 1 each per blister card, 24 per inner box, 288 per case. Approx. case wgt. 8 lbs.

Hook Remover

Two heads together can solve more problems than one, especially when you need to retract an engulfed hook. Simple and economical, this sturdy 6-3/4" hook remover features a small and large head for all hook sizes.

NO. 190

Packed 1 each per polybag with header card, 24 per inner box, 720 per case. Approx. case wgt. 32 lbs.



Trigger Hook Remover

No need to touch the fish or see the hook. Simply engage the leader, slide down over the shank of the hook and pull the trigger. This hook remover automatically reverses the hook so you can easily remove it. It features rugged plastic construction with a stainless steel wire eye.

NO. 195

Packed 1 each per blister card, 12 per inner box, 240 per case. Approx. case wgt. 29 lbs.



Pistol Grip Hook Remover

The right angle design of this pistol grip hook remover allows you a clear view when retracting swallowed hooks, lures and flies. Hand-to-jaw spring-action, serrated jaw and a corrosion-resistant zinc plating are the unique features that make this deluxe hook remover very functional and a superb value.

NO. BHR8

Packed 1 each per skin-pack card, 12 per inner box, 120 per case. Approx. case wgt. 52 lbs.



Hook Remover

This is just the instrument you need to remove a swallowed hook, lure or fly in a jiffy. Spring-loaded action, grip-tight jaws and zinc-plating that is tough on corrosion make this the ideal hook remover.

NO. HR8

Packed 1 each per skin-pack card, 12 per inner box, 120 per case. Approx. case wgt. 47 lbs.

Quick-Trigger Hook Remover

From a panfish to a large mouth lunker, this hook remover instantly removes the hook without ever touching the fish. Simply put the fishing line in the guide slot and slide the hook remover down the line and over the shank of the hook. With the line drawn tight, pull the spring-loaded trigger and the hook is automatically removed... it's that easy! It is made of chrome-plated steel to resist corrosion.

NO. HR

Packed 1 each per skin-pack card, 12 per inner box, 120 per case. Approx. case wgt. 35 lbs.



Skinning Pliers

Skinning all types of fish is as easy as 1,2,3 with these superbly constructed skinning pliers! They feature a 1-1/4" width jaw, firm spring-loaded grip and a plated finish that acts tough on corrosion.

NO. 4976

Packed 1 each per polybag with header card, 12 per inner box, 120 per case. Approx. case wgt. 32 lbs.



Fish Mouth Spreader

This jaw spreader holds the mouth wide open while you remove a hook or scale and clean your catch. Easy to use, simply insert it into the fish's mouth, turn and disengage the spring-loaded jaws. Made of spring steel and finished in black enamel to resist corrosion.

NO. FMS

Packed 1 each per skin-pack card, 12 per inner box, 120 per case. Approx. case wgt. 14 lbs.



Jumbo Fish Mouth Spreader

Made for large, heavy-mouthed fish, this jumbo fish mouth spreader holds the fish's jaws wide open while you easily remove the hook or clean and scale your prize. A snap to use, simply insert the spreader into the fish's mouth, turn and disengage the spring-loaded jaws. Made of spring steel and finished in black enamel to resist corrosion.

NO. FMSJ

Packed 1 each per skin-pack card, 12 per inner box, 120 per case. Approx. case wgt. 19 lbs.



Fish Scaler

Make quick, light work of scaling fish with this rust resistant 7" scaler. Features include a double row of serrated teeth and a tapered design for those hard to reach places.

NO. FS7

Packed 1 each per polybag with insert card, 12 per inner box, 120 per case. Approx. case wgt. 16 lbs.



Rubber Handle Scaler

With the comfortable, angled sure-grip, rubber handle, you can scale your prize catch in seconds. This great tool resists rust and has double-bladed construction with 2 rows of serrated teeth for lightening fast scaling.

NO. FSRH

Packed 1 each per polybag with header card, 12 per inner box, 120 per case. Approx. case wgt. 51 lbs.



Deluxe Skinning Pliers

The mighty jaws of these skinning pliers make it a breeze to skin any type of fish. They feature extra heavy-duty, 1-1/2" wide chrome-plated jaws for maximum gripping power, and spring-loaded, vinyl-coated handles for good control and a sure grip.

NO. DSP2

Packed 1 each per skin-pack card, 12 per inner box, 60 per case. Approx. case wgt. 33 lbs.

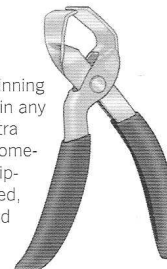

Surgical Pliers with Scissors

This 6" combination pliers and scissors is one of the handiest fishing tools you can own. Cutting blades clip monofilament, while serrated jaws remove hooks and crimp split-shot. Locks closed for use as a stream-side vise.

NO. PHS6

Packed 1 each per blister sleeve, 12 per inner box, 144 per case. Approx. case wgt. 19 lbs.



Fishing Scissors

These stainless steel scissors have large plastic finger loops that are comfortable and easy to use. The efficient design of this great utensil has a serrated plier nose to crimp split-shot and work as a hook remover. It's small enough for a tackle box or vest pocket.

NO. FS1

Packed 1 each per blister sleeve, 12 per inner box, 144 per case. Approx. case wgt. 14 lbs.

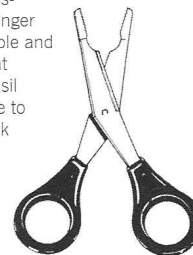

Sportsman's Shears

This handy, full sized 8" game and fish shears features high carbon, stainless steel blades and comfortable molded handles with built-in vise gripping jaws. These indispensable shears are made with the outdoor enthusiast in mind to provide options that are not practical with a knife. Lightweight and easy to use, these shears are great for many household uses.

NO. FS8

Packed 1 each per blister card, 12 per inner box, 144 per case. Approx. case wgt. 41 lbs.

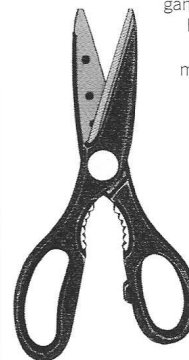

Folding Scissors

Neatly folding for compact storage, these durable scissors feature stainless steel blades and chrome-plated handles. Great for fishing, camping or traveling.

NO. 67100

Packed 1 each per blister card, 24 per inner box, 288 per case. Approx. case wgt. 15 lbs.

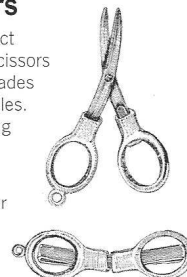

Long Nose Pliers

These long nose pliers are a must for every fisherman's tackle box or vest. Made of high-carbon steel, they feature tight-grip jaws, sharp cutting edge and EVA foam sure-grip handles.

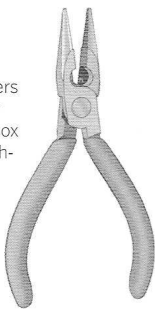

Packed 1 each per blister sleeve, 12 per inner box, 48 per case.

NO.	size	approx. case wgt.
T5	5"	13 lbs.
T6	6"	17 lbs.
T8	8"	25 lbs.

Bent Nose Pliers

These bent nose pliers make it easier to see as you work on small items. Made of high-carbon steel, they have tight-grip jaws and EVA foam sure-grip handles.

Packed 1 each per blister sleeve, 12 per inner box, 48 per case.



NO.	size	approx. case wgt.
CL6	6"	17 lbs.
CL8	8"	25 lbs.

Long Nose Pliers with Nylon Sheath

Quick and easy access to pliers is made possible with the holster style sheath made of tough, oxford nylon. Available with 6" or 8" long nose pliers.

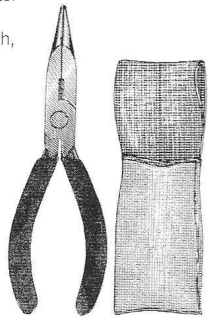

Packed 1 each per blister sleeve, 12 per inner box, 48 per case.

NO.	size	approx. case wgt.
T6S	6"	18 lbs.
T8S	8"	26 lbs.

Diagonal Cutter

These diagonal cutters with EVA foam sure-grip handles are the perfect tool for cutting all types of line and lead wire. Its 5" size makes it ideal to slip into a vest pocket or carry along in a tackle box.

NO. DC5

Packed 1 each per blister sleeve, 12 per inner box, 48 per case. Approx. case wgt. 13 lbs.



Stainless Steel Long Nose Pliers

Stainless steel construction and spring action design make these 6" long nose pliers an ideal fishing tool for pinching, crimping and cutting. Features include soft vinyl grip handles and a heavy-duty nylon sheath with spring steel belt clip.

NO. PSLN6

Packed 1 each per clam-pack with insert label, 12 per inner box, 48 per case. Approx. case wgt. 16 lbs.

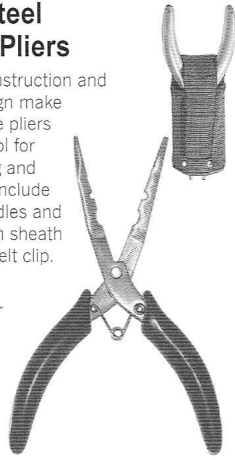

Stainless Steel Bent Nose Pliers

Made for cutting line, wire leader and lead wire these 4-1/2" stainless steel side cutter pliers are an ideal fishing tool. Spring action opens pliers when grip is released. Features include soft vinyl grip handles and a heavy-duty nylon sheath with spring steel belt clip.

NO. PSBN6

Packed 1 each per clam-pack with insert label, 12 per inner box, 48 per case. Approx. case wgt. 15 lbs.

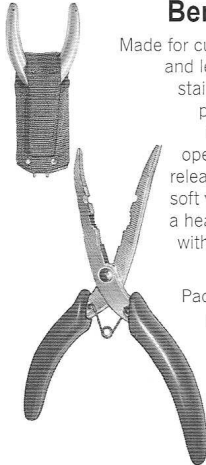

Stainless Steel Side Cutter Pliers

Made for cutting line, wire leader and lead wire these 4-1/2" stainless steel side cutter pliers are an ideal fishing tool. Spring action opens pliers when grip is released. Features include soft vinyl grip handles and a heavy-duty nylon sheath with spring steel belt clip.

NO. PSSC4

Packed 1 each per clam-pack with insert label, 12 per inner box, 48 per case. Approx. case wgt. 15 lbs.

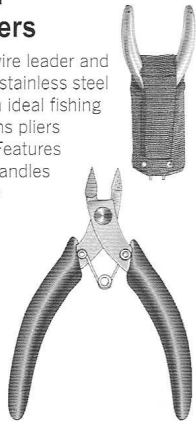

Stainless Steel Split Ring Pliers

Engineered with a hooked nose for opening split rings these 5-3/4" stainless steel pliers also pinch, crimp and cut. Spring action opens pliers when grip is released. Features include soft vinyl grip handles and a heavy-duty nylon sheath with spring steel belt clip.

NO. PSSR6

Packed 1 each per clam-pack with insert label, 12 per inner box, 48 per case. Approx. case wgt. 16 lbs.

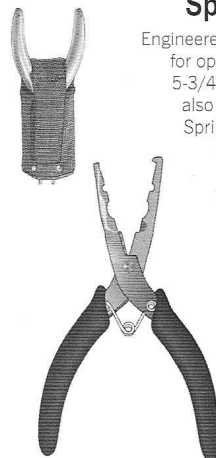

Lead Wire Pliers

Specifically designed to cut, flatten and punch lead wire these 7" long-nose, split-ring pliers are a must for the steelheader. Made of high-carbon steel and fitted with EVA foam sure-grip handles they feature a unique punch pin and a crimp-free cutting surface for hollow core wire.

NO. LWP7

Packed 1 each per blister sleeve, 12 per inner box, 48 per case. Approx. case wgt. 22 lbs.

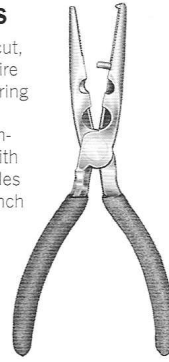

Split Ring Pliers

Designed to do more than just split rings, these pliers also serve as wire cutters and crimp a variety of leader sleeves and line stops. Also serving as a device to open split-shot without the danger of cutting the line, these pliers feature a chrome-plated finish and vinyl-coated handles for a sure grip.

NO. SRP

Packed 1 each per blister card, 24 per inner box, 240 per case. Approx. case wgt. 46 lbs.



Long Nose Split Ring Pliers

These small 5" vest pocket size long nose pliers are designed with a special hook nose that easily opens most any split ring. Made of polished high-carbon steel with EVA foam sure-grip handles.

NO. SRPLN5

Packed 1 each per blister sleeve, 12 per inner box, 48 per case. Approx. case wgt. 11 lbs.



Spring-Action Long Nose Split Ring Pliers

Designed with a special hook nose that easily opens most any split ring, these 6" long nose pliers feature spring-loaded construction so they snap open when released. Featuring three crimping functions and made of polished high-carbon steel with EVA foam sure-grip handles.

NO. SRPLN6

Packed 1 each per blister sleeve, 12 per inner box, 48 per case. Approx. case wgt. 13 lbs.

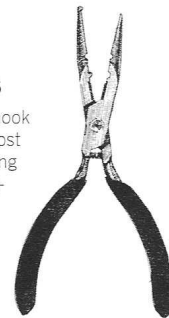

Stainless Steel Long Nose Pliers

Constructed with corrosion resistant 420 stainless steel these 7" long nose pliers feature comfortable sure-grip molded rubber handles. Tight-grip jaws and sharp cutting blades are designed to work hard.

NO. PL7SS

Packed 1 each per blister sleeve, 12 per inner box, 48 per case. Approx. case wgt. 20 lbs.



Sportsman's Pliers

Perhaps the finest multi-purpose fishing pliers ever made! These 5" corrosion-resistant, tempered steel pliers have vise-like jaws that won't let go! Strong, razor sharp cutters and spring-loaded, vinyl-coated handles offer control and a non-slip grip.

NO. 4969S

Packed 1 each per blister card, 12 per inner box, 120 per case. Approx. case wgt. 47 lbs.

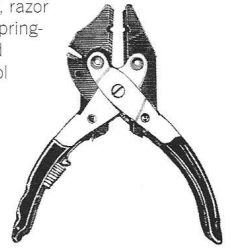

Chrome Vanadium Crimping Pliers

These heavy-duty 10" pliers crimp all sizes of leader sleeves and line stops. They cut all sizes of braided and solid steel fishing lines as well. Forged with high-carbon steel and featuring hardened crimping and cutting surfaces, these pliers have EVA foam sure-grip handles. They are the perfect companion for saltwater and freshwater fishing.

NO. FC10

Packed 1 each per blister sleeve, 12 per inner box, 48 per case. Approx. case wgt. 54 lbs.

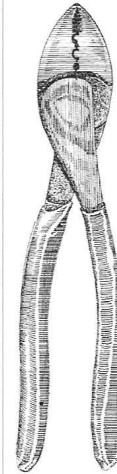

Pliers Head 14-In-1 Multi-Function Tool

Designed for maximum comfort, this quality 14-in-1 tool features a contoured handle design with nylon covers. Made of stainless steel, functions include: pliers, knives, cutters, screwdrivers, can and bottle openers, scaler, hook remover and file. Folding to 4", individual tools store within the handle. Complete with a durable oxford nylon belt sheath.

NO. MFT14

Packed 1 each per blister sleeve, 12 per inner box, 60 per case. Approx. case wgt. 38 lbs.

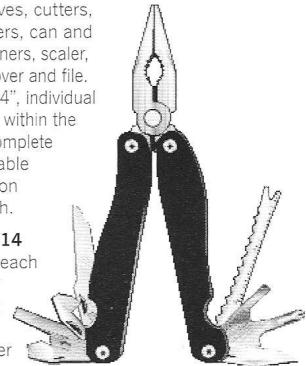

Pliers Head 10-In-1 Multi-Function Tool

Designed for the fisherman, this handy 10-in-1 tool folds to 2-1/2" with individual tools stored within the handle. Functions include: pliers, crimping tool, scissors, tweezers, hook sharpener, wrench, cutter, spike, knife and lanyard attachment.

Made of stainless steel, it features nylon handle covers and oxford nylon belt sheath.

NO. MFT10

Packed 1 each per blister sleeve, 12 per inner box, 60 per case. Approx. case wgt. 22 lbs.



Arctic Tip-Up

The Arctic ice tip-up is made of high-impact plastic and features stainless steel trip shaft, flag spring and line guide. Provides either soft or hard strike settings and features a lubricated center tube for no-freeze operation.

Frame is V-shaped for easy removal from ice and has molded, raised increment rulers in both inches and centimeters. Available with either standard or large capacity reel.

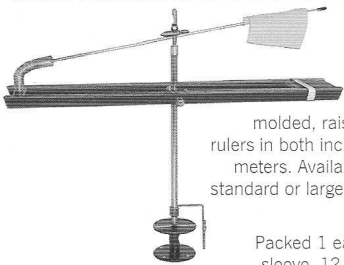

NO. ATU

Packed 1 each per blister sleeve, 12 per inner box.

code	reel capacity	each/case	approx. case wgt.
200	200'	24	30 lbs.
500	500'	24	32 lbs.

Sure-Set Tip-Up

The Sure-Set ice tip-up is made of high-impact plastic and features foldaway cross legs for convenient setup and take-down. Trip shaft tube is lubricated for no-freeze operation and a sensitive trigger-released signal flag extends extra high for easy visibility. Available with either standard or large capacity reel.

NO. EPTU

Packed 1 each per blister sleeve, 12 per inner box.

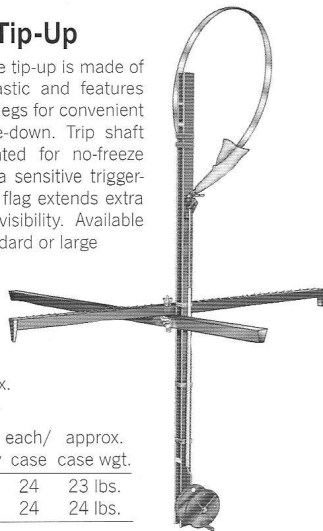

code	reel capacity	each/case	approx. case wgt.
200	200'	24	23 lbs.
500	500'	24	24 lbs.

Wood Tip-Up

Designed with foldaway cross legs for convenient setup and take-down this hardwood tip-up features a bite-sensitive, positive trip mechanism and high visibility signal flag. Available with standard capacity reel this tip-up provides no-freeze operation.

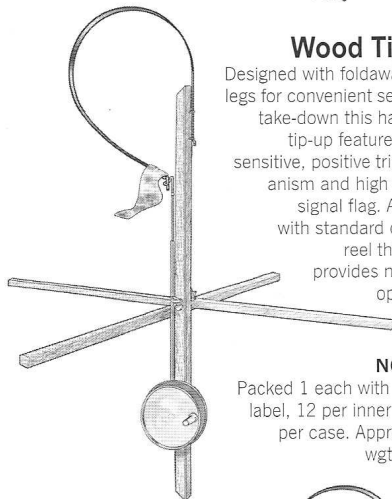

NO. IFTU

Packed 1 each with stick-on label, 12 per inner box, 60 per case. Approx. case wgt. 31 lbs.

Gamefish Tip-Up Kit

This gamefish kit features a hardwood tip-up with a bite-sensitive, positive trip mechanism, high visibility signal flag and standard capacity reel. Kit includes braided ice line, wire leaders, line markers, depth finder weights, split-shot sinkers, hooks and a tackle box.

NO. IFKN21

Packed 1 kit per clamshell, 6 per case. Approx. case wgt. 7 lbs.

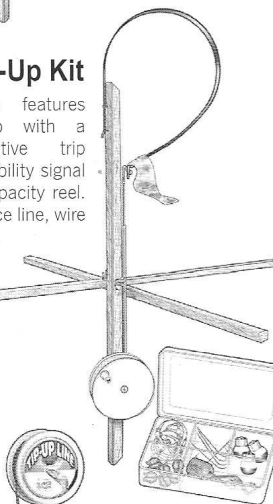

Panfish Ice Fishing Kit

This complete, rigged and ready to fish panfish kit features a solid glass jig pole and an adjustable drag rattle reel spool with monofilament line. Kit includes ice jigs, hooks, bobbers, split-shot sinkers, depth finder weight, tackle box and ice skimmer.

NO. IFKP24

Packed 1 kit per clamshell, 6 per case. Approx. case wgt. 9 lbs.



Jig Pole with Rattle Reel

This ready to fish kit includes a solid glass jig pole and an adjustable drag rattle reel spooled with monofilament line. Rigged with a sponge bobber and gold Aberdeen hook this combo features a comfortable foam handle and fluorescent red tip for easy visibility.

NO. JPRR25

Packed 1 each per polybag with header card, 12 per inner box, 48 per case. Approx. case wgt. 14 lbs.



Silver Eagle Ice Rods

Silver Eagle ice rods feature slip ring reel seats, EVA foam handles and multiple snake guides to accommodate lighter weight lines and to improve line feed. Solid glass blanks have a flat black finish highlighted with a bright red tip for improved visibility. The Silver Eagle series is available in two popular lengths.

NO. SE

Packed 1 each per polybag with hang tag, 10 per inner box, 50 per case.

code	length	action	approx. case wgt.
24UL	24"	ultra light	10 lbs.
30UL	30"	ultra light	11 lbs.

Economy Rattle Reel

The economy rattle reel attaches to jig pole or ice house wall. Features include an action rattle to signal fish strikes and a positive thumbscrew drag for setting line tension.

Includes two mounting screws.

NO. IFRE

Packed 1 each per polybag with header card, 12 per inner box, 144 per case. Approx. case wgt. 26 lbs.

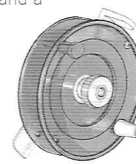

Wall Mount Rattle Reel

This ice house wall mount rattle reel is ideal for northerns, walleye and lake trout. The large capacity, reinforced 3-1/2" diameter spool features an action rattle to signal fish strikes. A positive, winged thumbscrew drag allows for easy setting of line tension, even with gloves on. Includes four mounting screws.



NO. IFRR

Packed 1 each per polybag with header card, 12 per inner box, 72 per case. Approx. case wgt. 23 lbs.

Rattle Reel with Clamp

This rattle reel is easily attached to stud or post with a heavy-duty, vinyl-dipped steel clamp. The large capacity, reinforced 3-1/2" diameter spool features an action rattle to signal fish strikes. A positive, winged thumbscrew drag allows for easy setting of line tension, even with gloves on.

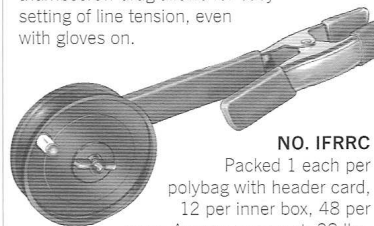

NO. IFRRC

Packed 1 each per polybag with header card, 12 per inner box, 48 per case. Approx. case wgt. 38 lbs.

Gold Eagle Ice Rods

Gold Eagle ice rods feature slip ring reel seats, thick EVA foam handles for comfort and extra large ceramic guides and tip top to reduce freeze-ups. Solid glass blanks have a flat black finish highlighted by gold color guide frames. The Gold Eagle series is available in a variety of popular lengths and actions.

NO. GE

Packed 1 each per polybag with hang tag, 10 per inner box, 50 per case.

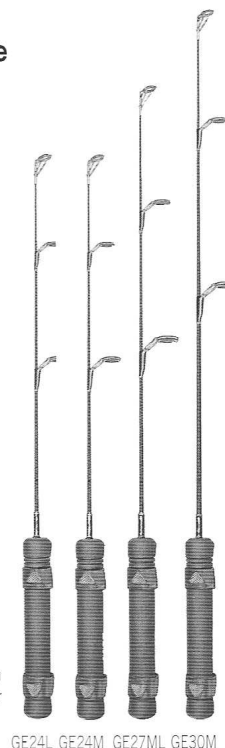

code	length	action	approx. case wgt.
24L	24"	light	12 lbs.
24M	24"	medium	13 lbs.
27ML	27"	medium-light	14 lbs.
30M	30"	medium	15 lbs.

Ice Jig Assortment 2-pack

Assortments feature two different jigs per card with cards assorted and mixed within the inner box to include teardrop, grub and glitter styles in the most popular colors. Half of the card assortments are size 8 and the other half size 6 hooks.



NO. IJA2

Packed 2 jigs per blister card, 12 cards per inner case, 288 per case. Approx. case wgt. 5 lbs.

Glow Ice Jig Assortment 2-pack

Assortments are finished in luminescent glow and feature two different jigs per card with cards assorted and mixed within the inner box to include teardrop, grub and glitter styles. Half of the card assortments are size 8 and the other half size 6 hooks.



NO. IJAG2

Packed 2 jigs per blister card, 12 cards per inner box, 288 per case. Approx. case wgt. 5 lbs.

Color Glow Ice Jig Assortment 2-pack

Featuring red, blue and green luminescent color glow finishes these assortments present two different jigs per card with cards assorted and mixed within the inner box to include teardrop, grub and glitter styles. Half of the card assortments are size 8 and the other half size 6 hooks.



NO. IJACG2

Packed 2 jigs per blister card, 12 cards per inner box, 288 per case. Approx. case wgt. 5 lbs.

Monofilament Ice Line

Formulated for ice fishing this nylon monofilament line retains flexibility and limpness in freezing conditions. Low stretch and high-tensile strength give this line excellent hook-setting capability. Packaged 100 yards per filler spool.

NO. ILMNC

Packed 1 spool skin-packed with label and pegboard tab, 12 per inner box, 288 per case.



code	yardage	lb. test	approx. case wgt.
2	100	2 lb.	13 lbs.
4	100	4 lb.	13 lbs.
6	100	6 lb.	13 lbs.
8	100	8 lb.	13 lbs.

Braided Ice Line

An ice fisherman favorite this premium braided black nylon line remains supple in freezing conditions and it resists "bite offs". Spooled to 50 yards this low stretch, low memory line is available in the most popular pound test sizes.



NO. ILBNB

Packed 1 each per shrink-wrapped spool, 12 per inner box, 240 per case.

code	yardage	lb. test	approx. case wgt.
15	50	15 lb.	40 lbs.
20	50	20 lb.	40 lbs.
25	50	25 lb.	39 lbs.
30	50	30 lb.	45 lbs.

Ice Jig Assortment

This 16-piece assortment includes a variety of teardrop, grub and glitter and rocker style ice jigs in the most popular colors and finishes and in the most commonly used sizes.

NO. IJA16

Packed 1 assortment per clam-pack, 12 per inner box, 144 per case. Approx. case wgt. 17 lbs.

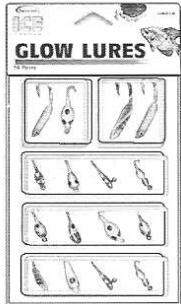
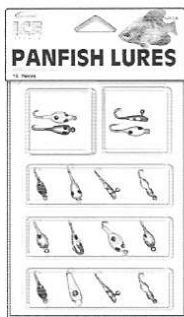

Glow Ice Jig Assortment

Featuring luminescent glow finishes this 16-piece assortment includes a variety of the most popular teardrop, grub and glitter and rocker style ice jigs in the most commonly used sizes.

NO. IJAG16

Packed 1 assortment per clam-pack, 12 per inner box, 144 per case. Approx. case wgt. 16 lbs.

Color Glow Ice Jig Assortment

This 16-piece assortment features red, blue and green luminescent color glow finishes in a variety of the most popular teardrop, grub and glitter and rocker style ice jigs in the most commonly used sizes.

NO. IJACG16

Packed 1 assortment per clam-pack, 12 per inner box, 144 per case. Approx. case wgt. 17 lbs.

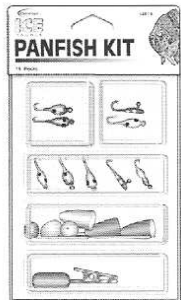
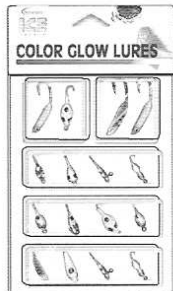

Panfish Ice Fishing Kit

This 16-piece panfish ice fishing kit features a variety of popular teardrop, grub and glitter style ice jigs. Included is a fluorescent red depth finder weight and bullet and teardrop floats with wood picks.

NO. IJK16

Packed 1 kit per clam-pack, 12 per inner box, 144 per case. Approx. case wgt. 17 lbs.

Depthfinder Weights

With a depthfinder weight attached to a dropline, you can quickly find and measure the depth of any lake. Mark your fishing line to indicate the bottom, then fish your way up until you determine the depth the fish are located.

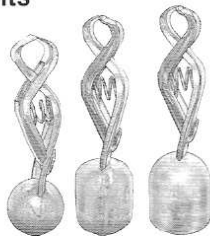

NO. DFW (natural)

NO. DFWFO (fluor. orange)

Packed 3 per polybag with header card, 12 bags per inner box, 144 per case.

code	weight	approx. case wgt.
3/4	3/4 oz.	18 lbs.
1-1/4	1-1/4 oz.	26 lbs.
1-1/2	1-1/2 oz.	31 lbs.

NO. DFWB (natural)

NO. DFWOB (fluor. orange)

Bulk packed 50 each per inner box, 500 per case.

code	weight	approx. case wgt.
3/4	3/4 oz.	26 lbs.
1-1/4	1-1/4 oz.	40 lbs.
1-1/2	1-1/2 oz.	50 lbs.

Lure Illuminator

This small key chain light is designed specifically for illuminating glow-in-the-dark lures and jigs. Encased in a stainless steel housing it features a purple spectrum light and a light-focusing lens to quickly charge luminescent glow finishes.



NO. LLCSP

Packed 1 each per blister sleeve, 200 per case. Approx. case wgt. 15 lbs.

Line Markers

Used to mark the surface and eliminate guessing when resetting tip-up line after a fish bite. This round 1/2" red and white line marker looks and attaches like a standard snap-on float.



NO. IFLM

Packed 3 per polybag with header card, 24 cards per inner box, 480 per case. Approx. case wgt. 8 lbs.

Sponge Bobbers

Ultra light and super sensitive these closed-cell foam bobbers are finished in high visibility fluorescent color.

Simply thread on and secure in the desired position with the accompanying wood pick.



NO. IFSPNGB

Packed 6 pieces per blister card, 12 cards per inner box, 480 per case. Approx. case wgt. 13 lbs.

Wire Spring Bobbers

Ultra sensitive, this light wire spring bobber with line guide, easily attaches to most rods. Adjustable for length, the spring sleeve locks the end loop onto the rod.

NO. IFSB

Packed 2 per blister card, 12 cards per inner box, 600 per case. Approx. case wgt. 25 lbs.

Flat Spring Bobbers

This ultra sensitive, super flat spring steel bobber easily attaches to most rods with shrink tubing included or with tape. Adjustable for length, these flat spring bobbers are available with highvisibility fluorescent or luminescent line guides.

NO. IFSBTG (glow)

NO. IFSBTS (fluor.)

Packed 2 per blister card, 12 cards per inner box, 480 per case. Approx. case wgt. 17 lbs.



Steel Ice Skimmer

Keep your fishing hole free of ice with this ice skimmer. Constructed of steel with zinc-plating that protects against corrosion, it has a 5-3/4" ladle and a 16-1/2" handle.

NO. 4516

Packed 1 each with stick-on label, 12 per inner box, 24 per case. Approx. case wgt. 19 lbs.

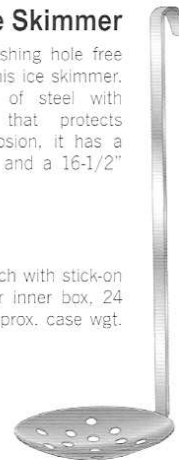

Chipper Dipper Ice Skimmer

Crowbar tough, the Chipper Dipper ice skimmer features a chisel point blade at handle's end and an etched 15" ruler. Welded steel construction is zinc-plated to resist corrosion. Skimmer measures 20-1/2" in length with a 5-7/8" diameter ladle.

NO. ISCD

Packed 1 each with stick-on label, 12 per inner box, 24 per case. Approx. case wgt. 35 lbs.



Plastic Ice Skimmer

All ice fishermen need this plastic ice skimmer for cleaning ice from the fishing hole. It has a 13" handle and a 4-3/4" diameter bright yellow basket. Ice can be squeezed off the flexible plastic basket in the coldest weather without breaking or losing its shape.

NO. ISP

Packed 1 each with stick-on label, 12 per inner box, 120 per case. Approx. case wgt. 21 lbs.

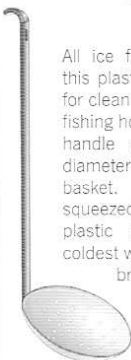

Telescopic Ice Skimmer

With a fully adjustable handle that telescopes from 23" to 38" this skimmer is perfect for thick ice. Simply twist to lock at desired length. The tubular steel handle features an enamel finish and a comfortable foam hand grip. Ladle has a 5" diameter and is zinc-plated to resist corrosion.

NO. IST

Packed 1 each with fold-over card, 12 per inner box, 24 per case. Approx. case wgt. 24 lbs.

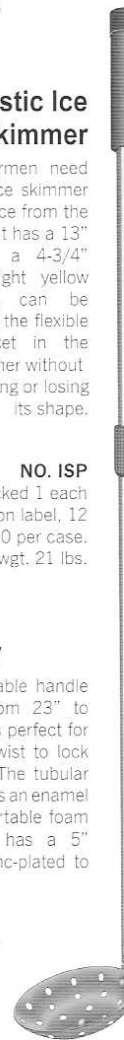

Slip-Over Ice Cleats

A must for winter sportsmen, these easy-on rubber cleats provide a positive traction on icy surfaces. Stretch rubber construction slips over most footwear and features full sole coverage with three double-rows of steel-toothed cleats.

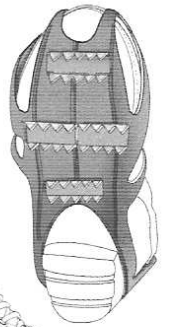

NO. IFCLR

Packed 1 pair per clam-pack, 12 pair per inner box, 24 per case.



code	size	approx. case wgt.
L	large	19 lbs.
XL	X-large	26 lbs.

Buckle-On Ice Cleats

Featuring rust resistant, light weight steel spikes, these ice cleats provide positive traction on icy surfaces. Designed for ice fishermen, they easily attach to any shoe or boot with a heavy-duty polypropylene strap fitted with a positive-lock, steel toothed buckle.

NO. IFCLB

Packed 1 pair per blister card, 12 pair per inner box, 144 per case. Approx. case wgt. 38 lbs.



Quick-On Ice Cleats

Designed for ice fishermen, these cleats are quickly and easily attached by simply drawing the elastic strap over the top of any shoe or boot, then securing it to the hook. Rust resistant, light-weight steel spikes provide traction on icy surfaces.

NO. IFCLE

Packed 1 pair per blister card, 12 pair per inner box, 144 per case. Approx. case wgt. 50 lbs.

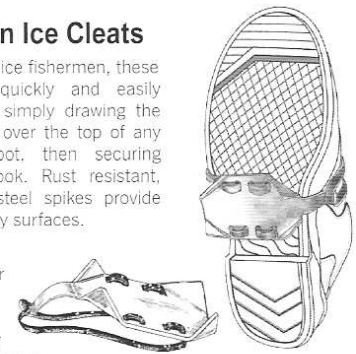

Ice Escape

A life preserver for ice fishermen and snowmobilers, these spikes allow you to pull yourself from broken ice. The snap together feature permits them to be worn around the neck for quick access in the event of an emergency.

NO. IFIE

Packed 1 per clam-pack with insert card, 12 per inner box, 72 per case. Approx. case wgt. 28 lbs.

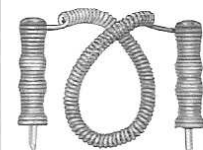

Depth and Temperature Gauge

This depth and temperature gauge makes it easy to locate fish by providing both the water temperature and the depth of the temperature reading. Simply place the gauge on a line and drop it to any depth, wait 40 seconds, then retrieve to read the depth and temperature indicators. To reset, empty water by pressing the valve and shaking briskly.

NO. FL

Packed 1 each per blister card, 12 per inner box, 144 per case. Approx. case wgt. 17 lbs.



Reel Grease

This reel grease is exactly what the pros recommend when it comes to protecting spinning, casting and trolling reels from wear, rust and corrosion. Packaged in a spill-proof 1/2 oz. tube, this reel grease reduces friction and is impervious to saltwater and temperature variations.



NO. RG3

Packed 1 each per blister card, 12 per inner box, 300 per case. Approx. case wtg. 25 lbs.

Reel Oil

Protect your valuable reel from wear, rust and corrosion with this penetrating oil. Specifically formulated for spinning, casting and trolling reels. A protective film of this oil helps ensure a greater lifespan for your reel. Packaged in a spill-proof 7/8 oz. container.



NO. RO1

Packed 1 each per blister card, 12 per inner box, 240 per case. Approx. case wtg. 28 lbs.

Sports Heat® Hand Warmers

Safe and non-toxic the Sports Heat® hand warmers fit comfortably in gloves or mittens. Once opened and exposed to air, oxidation of the all-natural ingredients produces a continuous and controlled heat for up to 8 hours.

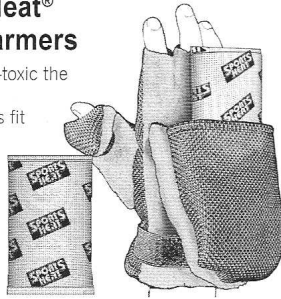

NO. 47200

Packed 1 pair per sealed package, 40 pair per display box, 320 per case. Approx. case wtg. 35 lbs.

Sports Heat® Toe Warmers

Safe and non-toxic the Sports Heat® toe warmers fit comfortably in shoes or boots with an adhesive backing holding them in place. Once opened and exposed to air, oxidation of the all-natural ingredients produces a continuous and controlled heat to keep toes warm for up to 5 hours.



NO. 47300

Packed 1 pair per sealed package, 20 pair per display box, 160 per case. Approx. case wtg. 15 lbs.

Sports Heat® Body Warmer

Safe and non-toxic the Sports Heat® body warmer can be placed in pockets or comfortably between layers of clothing. Once opened and exposed to air, oxidation of the all-natural ingredients produces continuous and controlled heat for up to 20 hours.



NO. 47100

Packed 1 per sealed package, 30 per display box, 240 per case. Approx. case wtg. 33 lbs.

Solid Fuel Sticks

For use with Danielson® item number 507P Pocket Handwarmer shown below, these solid fuel sticks can be lighted quickly with a match or lighter. These charcoal fuel sticks will generate heat for up to 10 hours.

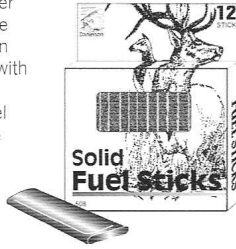

NO. 508

Packed 12 sticks per display box, 12 display boxes per inner box, 240 per case. Approx. case wtg. 47 lbs.

Pocket Handwarmer

A long time favorite of outdoorsmen, the pocket handwarmer keeps fingers toasty warm. This velvet covered handwarmer generates heat for up to 10 hours using solid fuel charcoal sticks. Instructions are included.

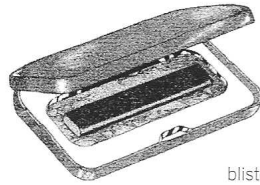

NO. 507P

Packed 1 each per blister card, 12 per inner box, 144 per case. Approx. case wtg. 38 lbs.

Rag Wool Half-Finger Gloves

A great choice these classic rag wool gloves are made of an 85% wool/15% nylon blend and feature double knit cuffs. Lightweight, warm and comfortable the half-finger design offers complete dexterity for intricate tasks.



NO. 5505

Packed 1 pair with header card and peg hook, 12 pair per inner box, 144 per case.

code	size	approx. case wtg.
M	medium	34 lbs.
L	large	35 lbs.

Field Dressing Knife with Sheath

Fast, safe and more efficient than straight-bladed knives this field dressing tool is engineered for opening and skinning big game. The ripping grip opens game from the inside out while the all-purpose grip is for skinning and cutting. Features

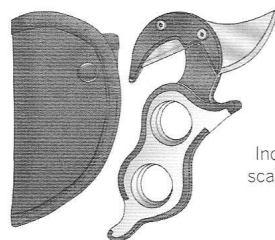

include replaceable one-piece blade and ergonomically contoured frame with finger holes for a secure grip. Includes oxford nylon scabbard, extra blade, blade cover and changing tool.

NO. SKS

Packed 1 each per clam-pack with insert label, 12 per inner box, 72 per case. Approx. case wtg. 23 lbs.

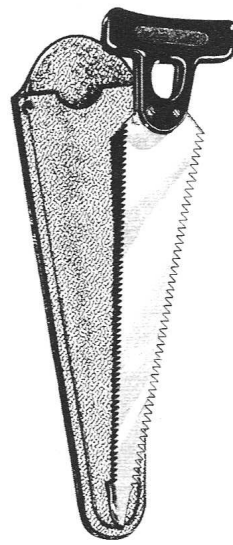

Pack Saw

The perfect pack saw for big game hunting, the double-edged, high-carbon steel blade of this saw has fine teeth on one edge and coarse teeth on the other. Concealed in the aluminum handle is a waterproof match compartment. The stitched synthetic leather sheath protects the 13", 9 oz. saw.

NO. 7560-021

Packed 1 each per blister sleeve, 12 per inner box, 72 per case. Approx. case wtg. 44 lbs.

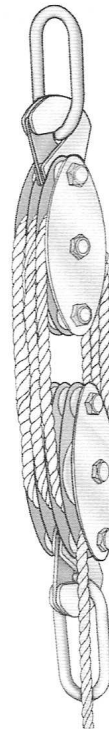

Pulley Hoist

Used by hunters to lift game for dressing, this heavy-duty hoist includes such rugged features as a plated steel pulley with nylon rollers and 65 feet of 3/16" polyrope.

NO. 2000

Packed 1 each per vinyl bag with header card, 24 per case. Approx. case wtg. 38 lbs.

Tangle Free Decoy Line 100'

This solid PVC plastic decoy line is smooth, flexible and tangle free; and, it will not freeze, crack, float or rot. Made abrasion resistant and designed to stretch before breaking. No need to wind for storage, just drop in the decoy bag.



NO. DCPB100

Packed 100' per spool in a clam-pack, 12 per inner box, 72 per case. Approx. case wtg. 41 lbs.

Tangle Free Decoy Line 250'

This solid PVC plastic decoy line is smooth, flexible and tangle free; and, it will not freeze, crack, float or rot. Made abrasion resistant and designed to stretch before breaking. No need to wind for storage, just drop in the decoy bag.



NO. DCPB250

Packed 250' per spool in a clam-pack, 6 spools per inner box, 24 per case. Approx. case wtg. 41 lbs.

Braided Camouflage Decoy Line 100'

Finished in low visibility camouflage color this braided nylon decoy cord will not float or rot. Made abrasion and chemical resistant and features improved knot-holding ability.



NO. DCNC100

Packed 100' per spool in a clam-pack, 12 spools per inner box, 60 per case. Approx. case wtg. 23 lbs.

Line Crimps

These black anodized aluminum line crimps eliminate knots and make rigging decoys a snap. Simply thread cord through the crimp, set depth and secure with pliers.

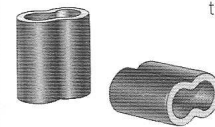

NO. LCRMP48

Packed 48 each per clam-pack with insert label, 12 packs per inner box, 288 per case. Approx. case wtg. 26 lbs.

Depth Adjusters

These decoy line cord locks adjust weight depth quickly and easily and eliminates winding and unwinding of cord. Features include push button release and stainless steel spring to keep the cord adjuster secure.



NO. CLCK24

Packed 24 each per clam-pack with insert label, 12 packs per inner box, 288 per case. Approx. case wtg. 7 lbs.

Anchor Weights

Set includes one dozen 3.5-oz lead anchor straps. Simply attach line to decoy keel and anchor strap, then adjust for water depth so strap rests on bottom.

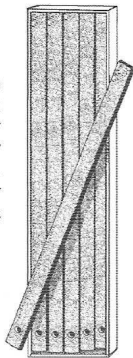

NO. AW

Packed 12 weights per display box, 12 boxes per case. Approx. case wgt. 34 lbs.

Stainless Steel Line Clips

Ideal for use with decoy cords and trot lines these stainless steel line clips ensure easy on/off application.

Simply squeeze open, hook line and release to secure, spring tension holds firm.



NO. LCLIP24

Packed 24 each per clam-pack with insert label, 12 packs per inner box, 72 per case. Approx. case wgt. 27 lbs.

Whistle with Lanyard

Great for backpackers, fishermen and boaters this nickel-plated brass whistle includes a handy lanyard that attaches to a pack, clothing or person.

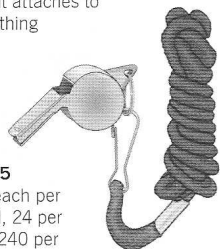

NO. 69375

Packed 1 each per blister card, 24 per inner box, 240 per case. Approx. case wgt. 19 lbs.

Ground Spike

Designed to penetrate the hardest ground, these 10" plated steel spikes can be used to secure ropes or floor loops and serve as a great ground anchor. The spikes feature an ABS plastic stopper.

NO. 68230

Bulk packed 25 each per inner box, 100 per case. Approx. case wgt. 24 lbs.

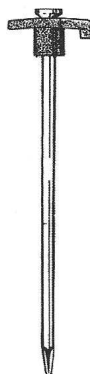

Utility Cord

For hunting, camping, traveling and around home, this 100 ft. hank of 3/16" diameter braided nylon cord is olive drab in color.

NO. 61772

Packed 1 each per polybag with header card, 12 per inner box, 72 per case. Approx. case wgt. 21 lbs.

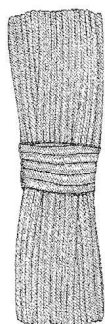

40-Piece First Aid Kit

A must have accessory for fishing, camping, boating, cycling or any outdoor recreational activity. This 40-piece kit includes bandages, antiseptics, ointments, sting relief pads, non-aspirin tablets, electrolyte tablets, safety pin and even instructions for removing an embedded fish hook. Conveniently packed in a water tight, bright yellow plastic container with a handy cord carry handle.

NO. FA41

Packed 1 each per clam-pack, 6 per inner box, 60 per case. Approx. case wgt. 15 lbs.



32-Piece First Aid Kit

A terrific take-along first aid kit for fishing, camping, hunting or any outdoor recreational activity. This 32-piece kit includes bandages, antiseptics, ointment, non-aspirin tablets, electrolyte tablets and even instructions for removing an embedded fish hook. Conveniently packed in a safety orange nylon pack.

NO. FA32

Packed 1 each per clam-pack, 6 per inner box, 60 per case. Approx. case wgt. 14 lbs.



Pin-On Ball Compass

A sturdy brass pin attaches this convenient and easy to read ball compass to clothing or pack. The liquid filled compass has a luminous marked floating dial in a rugged plastic housing. Dial always remains upright for easy reading.

NO. 61566

Packed 1 each per blister card, 24 per inner box, 144 per case. Approx. case wgt. 9 lbs.

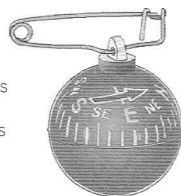

Portable Jon

This convenient and reusable urinal is a must have companion when you're boating, traveling and camping. Made of plastic that is easy to clean, this jon features a lock-tight lid to prevent leaks. Female Adapter, item number PJA, sold separately.

NO. PJ (red)

NO. PJOD (olive drab)

Packed 1 each per polybag with header card, 12 per inner box, 36 per case. Approx. case wgt. 16 lbs.

Jon Female Adapter

This adapter allows women to conveniently use the Portable Jon. Constructed of plastic, the Portable Jon and Female Adapter are indispensable companions when boating, traveling and camping. For use with Danielson® Portable Jon, item number PJ and PJOD, sold separately.

NO. PJA

Packed 1 each per polybag with header card, 12 per inner box, 144 per case. Approx. case wgt. 16 lbs.

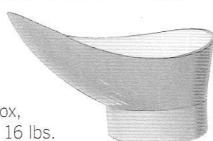

Anchor Pulley

This handy anchor pulley locks automatically with the weight of the anchor. And with the flick of the rope, the tension is released. The roller assembly extends over the gunwale to prevent scratching the boat's finish. Made of corrosion-resistant die cast aluminum.

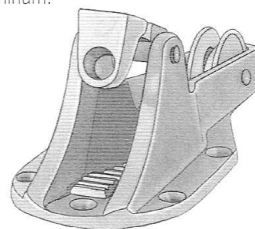

NO. 63181

Packed 1 each per polybag with header card, 6 per inner box, 24 per case. Approx. case wgt. 22 lbs.

Bow Chock with Roller

A precision roller makes this the perfect bow chock for heavier anchors. It is designed to keep an anchor rope centered over the bow and prevent marring of the boat's finish. Made of corrosion-resistant cast aluminum.

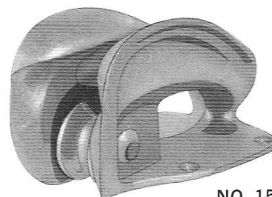

NO. 1546

Packed 1 each per polybag with header card, 6 per inner box, 24 per case. Approx. case wgt. 31 lbs.

Snap Handle Drain Plug

Made of durable brass, this plug works with 1" diameter drains. Simply snap the handle down to lock into place and raise the handle to remove.

NO. DPSH

Packed 1 each per blister card, 12 per inner box, 144 per case. Approx. case wgt. 27 lbs.

NO. DPSHB

Bulk packed 24 each per polybag, 240 per case. Approx. case wgt. 25 lbs.

T-Handle Drain Plug

A breeze to use, this brass drain plug works with 1" diameter drains. Simply turn the handle to either lock the plug in or to remove it.

NO. DPTH

Packed 1 each per blister card, 12 per inner box, 144 per case. Approx. case wgt. 20 lbs.

NO. DPTHB

Bulk packed 24 each per polybag, 240 per case. Approx. case wgt. 22 lbs.



Key Float with Chain

Your keys won't sink to the bottom of the lake with this floating key chain. Made of closed-cell foam, this sturdy key ring holds approximately five keys and comes in high visibility yellow.

NO. KFA

Packed 1 each per polybag with header card, 24 per inner box, 24 per case. Approx. case wgt. 10 lbs.



Motor Flusher

A must for all boats, this easy to use motor flusher helps prevent clogging and corrosion by flushing away sand, silt, and debris.

NO. FMR

Packed 1 each per cardboard sleeve, 12 per inner box, 48 per case. Approx. case wgt. 43 lbs.

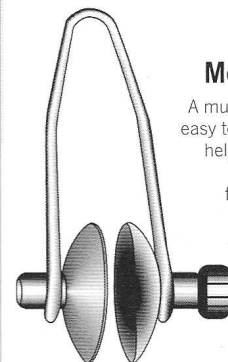

Boat Flag

Made of durable PVC, and measuring 14-1/2" x 12" with a 24" long handle, this bright orange flag catches everyone's attention when water-skiers fall. This flag is required in AZ, CA, CO, ID, MO, NE, NM, OR, TX, UT, and WA.

NO. FB

Packed 1 each with tension card, 12 per inner box, 144 per case. Approx. case wgt. 38 lbs.

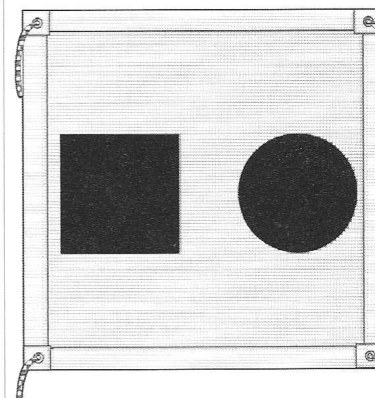
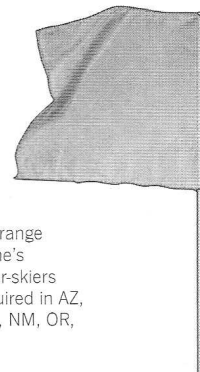

Boat Distress Flag

This 3' x 3' high visibility orange flag with black universal distress symbol printed on both sides is easily seen from the air or water and is recommended on all boats.

NO. FBD

Packed 1 each per polybag with fold-over header card, 12 per inner box, 48 per case. Approx. case wgt. 27 lbs.

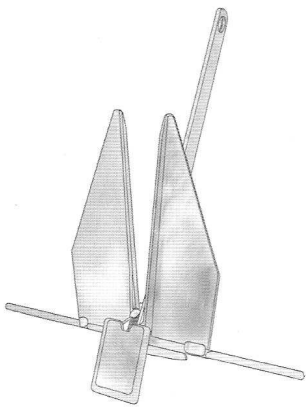

Fluke Anchor

These penetrating fluke anchors are polymer coated and designed to dig into mud, sand, or gravel. The design of the fluke anchor allows for excellent weight-to-holding power ratio, and the low profile allows for easy storage. Available in 5 sizes.

NO. AFLUKEG

Packed 1 each with stick-on label.

code	weight	pcs./basket	approx. basket wgt.
4	4 lbs.	300	1540 lbs.
8	8 lbs.	150	1540 lbs.
13	13 lbs.	110	1540 lbs.
18	18 lbs.	70	1540 lbs.
22	22 lbs.	60	1540 lbs.

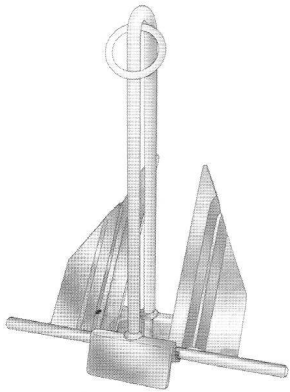

Slip Ring Anchor

The slip ring shank of these corrosion resistant aluminum magnesium alloy anchors are designed for easy retrieval in areas where snagging can occur. They feature a light weight design that will out perform heavier steel anchors, making them easy to handle. Available in 4 sizes.

NO. ASLIPG

Packed 1 each with stick-on label.

code	weight	pcs./basket	approx. basket wgt.
4	4 lbs.	260	1540 lbs.
8	8 lbs.	140	1540 lbs.
11	11 lbs.	120	1540 lbs.
13	13 lbs.	100	1540 lbs.

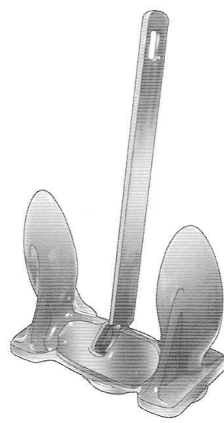

Navy Anchor

These vinyl-coated navy anchors combine weight with flukes and a penetrating swivel action to dig in and hold firmly in a wide range of water floors. The reverse action of the shank allows for quick retrieval. Available in 4 sizes.

NO. ANAVYV

Packed 1 each with stick-on label.

code	weight	pcs./basket	approx. basket wgt.
10	10 lbs.	250	2640 lbs.
15	15 lbs.	180	2640 lbs.
20	20 lbs.	160	2640 lbs.
28	28 lbs.	120	2640 lbs.

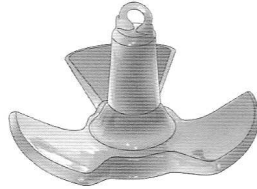

River Anchor

The vinyl-coated river anchor will catch and securely hold the river bottom where mud, rocks, stumps and brush are present due to the grappling action of its three individual blades. Available in 4 sizes.

NO. ARIVV

Packed 1 each with stick-on label.

code	weight	pcs./basket	approx. basket wgt.
12	12 lbs.	220	2640 lbs.
15	15 lbs.	200	2640 lbs.
18	18 lbs.	150	2640 lbs.
30	30 lbs.	90	2640 lbs.

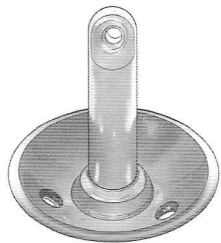

Mushroom Anchor

The vinyl-coated mushroom anchor is an economical solution for lightweight boats. The wide-area mushroom cup produces sufficient holding power in mud and weeds, while the vinyl-coating makes the anchor resistant to rust and abrasion. Available in 4 sizes.

NO. AMUSHV

Packed 1 each with stick-on label.

code	weight	pcs./basket	approx. basket wgt.
8	8 lbs.	320	2640 lbs.
10	10 lbs.	250	2640 lbs.
12	12 lbs.	220	2640 lbs.
15	15 lbs.	200	2640 lbs.

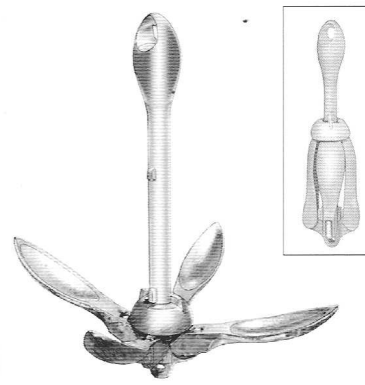

Folding Anchor

This galvanized, four-fluke anchor is lockable in an open or closed position and is perfect for personal watercraft and dinghies. Folds up easily for storage. Available in 4 sizes.

NO. AFOLDG

Packed 1 each with stick-on label.

code	weight	pcs./basket	approx. basket wgt.
3	3 lbs.	750	2640 lbs.
7	7 lbs.	300	2640 lbs.
9	9 lbs.	250	2640 lbs.
13	13 lbs.	200	2640 lbs.

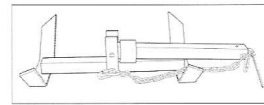

collapsed view

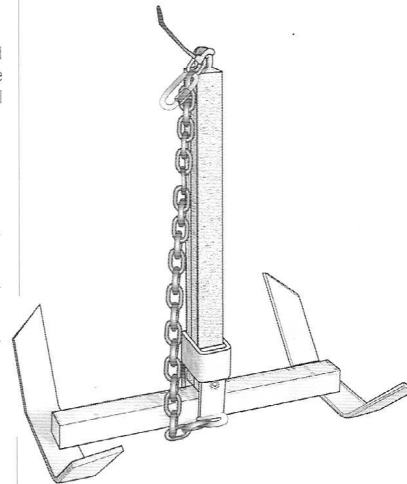

Collapsible Rocking Anchor

This galvanized, easy to store, collapsible rocking anchor is ideal in any river with heavy current and unforgiving bottom. The added break loose function for easy retrieval makes the anchor ideal for the Pacific Northwest or any heavy current conditions.

NO. AROCKG

Packed 1 each with stick-on label.

code	weight	pcs./basket	approx. basket wgt.
26	26 lbs.	120	3280 lbs.
32	32 lbs.	100	3360 lbs.

Drift Sock Harness

The most effective and easiest way to attach your drift sock anchor to the boat. This heavy duty harness comes ready to go and includes an egg float for locating your drift sock anchor and a "cheater" rope for easy retrieval.

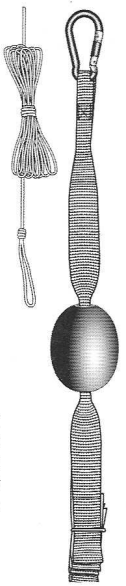

NO. DRFTSCKH

Packed 1 each per clam pack with header card, 6 each per inner box, 24 per case. Approx. case wgt. 16 lbs.



Drift Sock Anchor

This heavy duty functional drift sock anchor is great for stabilizing your boat in windy cross current conditions, and also can be used to slow your boat down when the current is too fast. High quality nylon straps make this drift sock anchor indestructible in any rough water conditions. Available in 4 sizes.

NO. ADRFTSCK

Packed 1 each per polybag with fold-over header card, 12 per inner box.

code	length	pcs./case	approx. basket wgt.
18	18"	144	34 lbs.
24	24"	144	40 lbs.
30	30"	72	40 lbs.
36	36"	72	49 lbs.

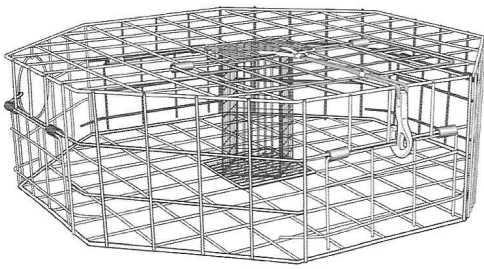

Octagon Crab Trap

Proven effective this octagon crab trap features a built-in bait cage and large top opening hatch with stretch tube and hook closure. Constructed of vinyl-coated steel wire it measures 30" x 30" x 9". Outfitted with four entrance doors, two escape rings for smaller crabs and fall-away rot-cord system to disable the trap should it not be retrievable.

NO. CTO4

Packed 1 each with fold-over tag, 1 per case. Approx. case wgt. 13 lbs.

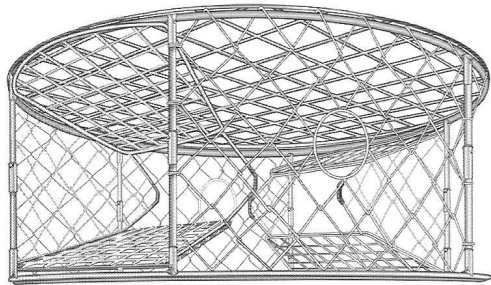

Stainless Steel Collapsible Crab Trap

Designed for the commercial or weekend crabber this circular crab trap features two entrance tunnels and two escape rings. Constructed of stainless steel it measures 30" in diameter with a hinged lid for easy crab removal. And it collapses for easy storage.

NO. CTSSC

Packed 1 each with fold-over tag, 1 per case. Approx. case wgt. 13 lbs.

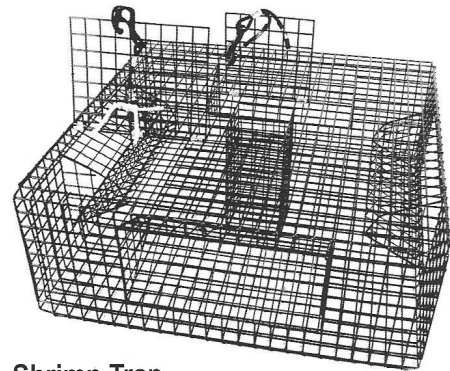

Shrimp Trap

This trap has proven itself to be a must have for serious shrimpers. Constructed of vinyl-coated steel wire it measures 24" L x 24" W x 13" H. It features a built-in bait cage, two large top opening hatches secured with a stretch tube and hook closure. Outfitted with four entry ramps, one on each side for multiple approaches, and fall-away rot cord system to disable the trap should it not be retrievable.

NO. ST78

Packed 1 each with fold-over tag, 1 per case. Approx. case wgt. 14 lbs.

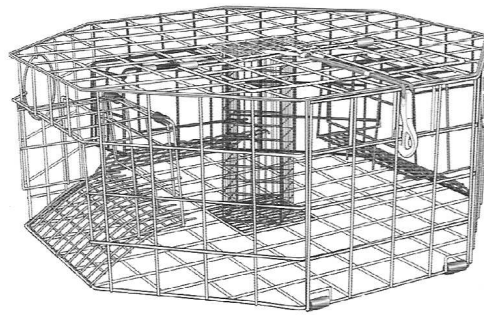

Octagon Crab Trap with Ramp Entrances

Designed with ramp entrances for improved effectiveness this octagon crab trap features a built-in bait cage and large top and side opening hatches secured with a stretch tube and hook closure. Constructed of vinyl-coated steel wire it measures 30" x 30" x 12". Outfitted with three ramped entrance doors, two escape rings for smaller crabs and fall-away rot-cord system to disable the trap should it not be retrievable.

NO. CTO3R

Packed 1 each with fold-over tag, 1 per case. Approx. case wgt. 10 lbs.

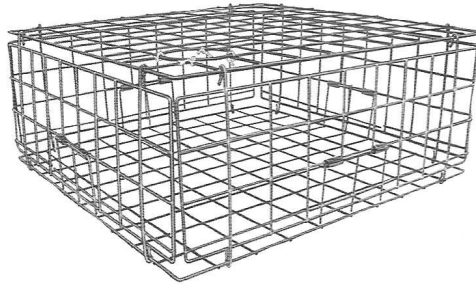

Jumbo Pacific FTC Crab Trap

This jumbo version of Danielson's® exclusive FTC crab trap measures 30" L x 30" W x 13" H and is constructed with an extra heavy gauged vinyl-coated wire floor panel to handle larger catches. Folding flat for easy transport and storage it features four entrance doors and two escape rings for small crabs with fall-away rot-cord system to disable the trap should it not be retrievable.

NO. FTCJ

Packed 1 each per polybag with fold-over tag, 3 per case. Approx. case wgt. 49 lbs.

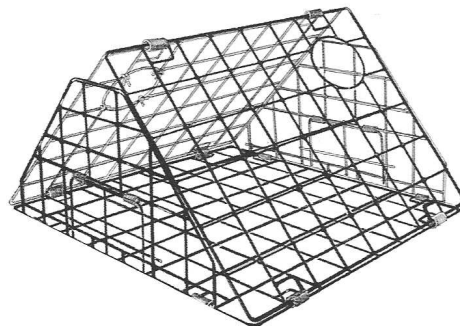

Pacific Apex Crab Trap

The patented A-frame design of this crab trap features exclusive twist-lock tubular hinges for easy set-up and take-down. Constructed with steel wire and vinyl-coated to resist corrosion it folds flat to its 24" square floor size. Equipped with entrance doors at both ends and two escape rings for small crabs with fall-away rot-cord system to disable the trap should it not be retrievable.

NO. CTA24

Packed 1 each per polybag with fold-over tag, 6 per case. Approx. case wgt. 45 lbs.

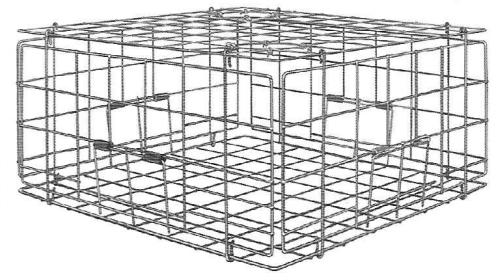

Pacific FTC Crab Trap

Danielson's® exclusive FTC crab trap is a favorite of sport and recreational crabbers throughout the Pacific Northwest. Constructed of vinyl-coated steel wire it measures 24" L x 24" W x 13" H. Folding flat for easy transport and storage it features four entrance doors and two escape rings for small crabs with fall-away rot-cord system to disable the trap should it not be retrievable.

NO. FTC

Packed 1 each per polybag with fold-over tag, 6 per case. Approx. case wgt. 55 lbs.

Alaska FTC Crab Trap (not shown)

This version of the exclusive Danielson's® FTC crab trap is modified to meet Alaska's biodegradable opening requirements.

NO. FTCAK

Packed 1 each per polybag with fold-over tag, 6 per case. Approx. case wgt. 55 lbs.



Conical Crab Trap with Float and Harness

This easy to use conical trap allows crabs access from any direction. The slope of the tightly tied polypropylene side is readily scaled by crabs getting to the bait. Once inside, the trap acts like a holding pen even after the bait is gone. Made with a vinyl-coated steel framework, it features a 34" lower ring and 18" upper ring connected by five strong supports. Its conical shape gives the trap a low center of gravity to ensure upright landing. The trap comes complete with harness and float and can be stacked one on top of the other for convenient storage.

NO. CCP34

Packed 1 per polybag with header card, 6 per case. Approx. case wgt. 44 lbs.

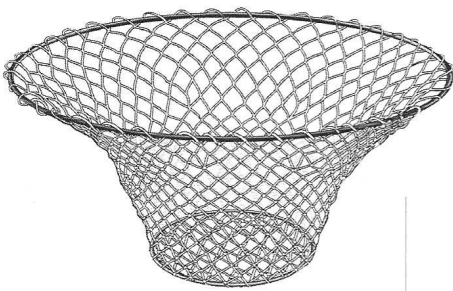

Pacific Crab Net

Made for larger West coast crabs, this deluxe crab net features a 32" upper steel ring and 12" lower ring. Sixteen inches deep, it prevents escape during retrieval. Made of rugged polypropylene netting for long lasting wear, this net easily holds a big catch!

NO. D5G

Packed 1 each with fold-over tag, 12 per case. Approx. case wgt. 49 lbs.

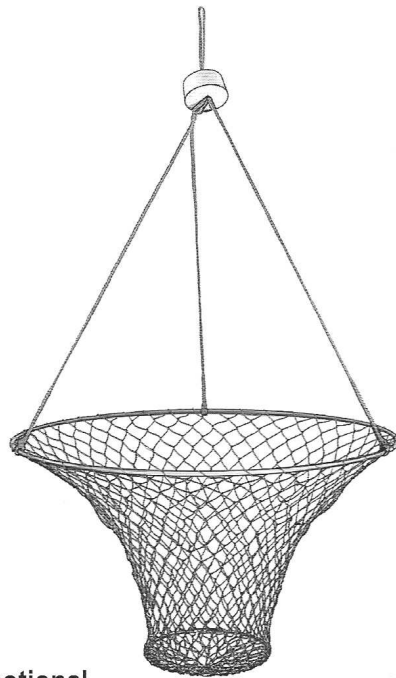

Promotional Pacific Crab Net & Harness

This promotional version of the Pacific style crab net comes complete with a braided-on rope harness and harness float. Galvanized steel rod construction features a 30" upper ring and 10" lower ring and rugged polypropylene netting measuring 15" in depth.

NO. CREH

Packed 1 each with fold-over tag, 6 per case. Approx. case wgt. 28 lbs.

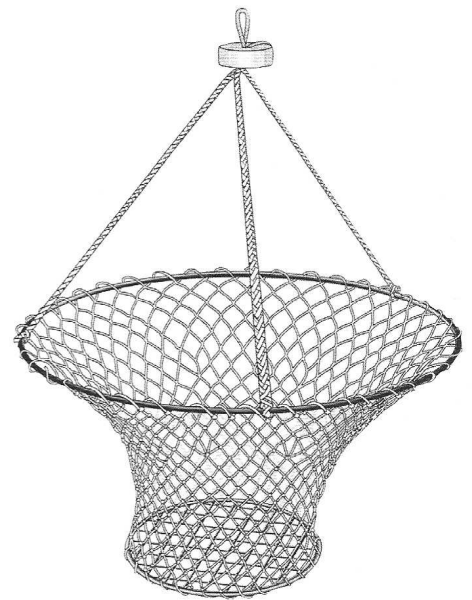

Deluxe Pacific Crab Net & Harness

Complete with braided-on rope harness and harness float this deluxe crab net features a wire grid bottom ring for easy bait attachment and improved crab retrieval and removal. Constructed with 32" vinyl-coated steel upper ring and 15" vinyl-coated wire grid bottom ring. Rugged polypropylene netting measures 16" deep.

NO. CRDLXH

Packed 1 each with hang tag, 6 per case. Approx. case wgt. 36 lbs.

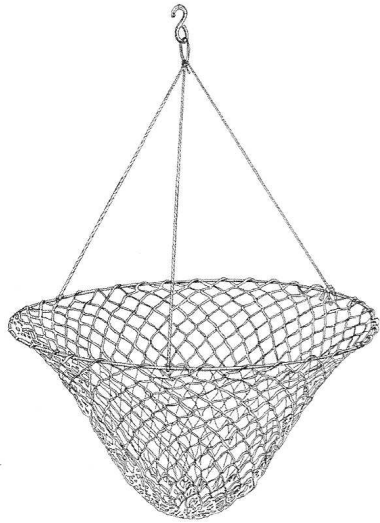

Single Ring Crab Net

A 12" deep, tapered cotton basket is featured with this 25" single ring crab net. Includes a 3-line cotton cord bridle and attachment hook for easy rigging to mainline.

NO. SR1

Packed 1 each with label, 24 per case. Approx. case wgt. 15 lbs.

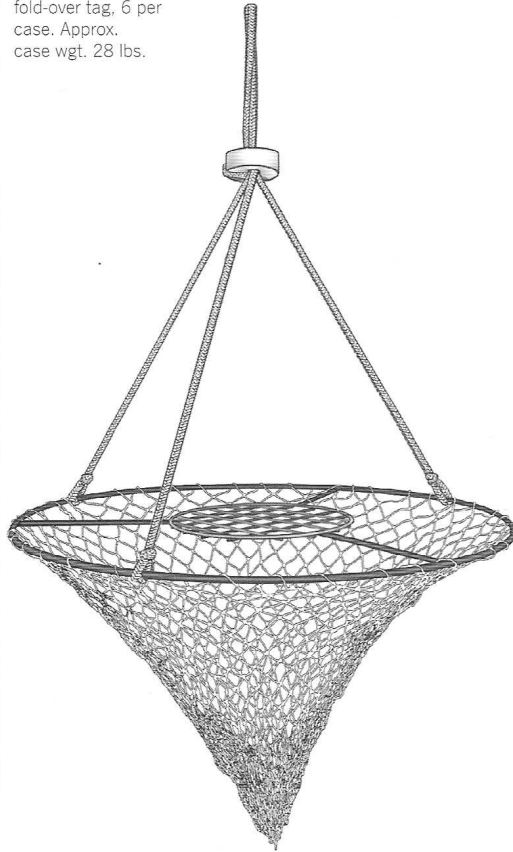

Castable Lobster and Crab Net with Harness

This lobster and crab net comes complete with braided-on rope harness and harness float. Vinyl-coated steel rod construction, this 32" single ring net has a built in 12" wire grid for easy bait attachment. Rugged polypropylene netting measures 20" deep.

NO. LCRCR

Packed 1 each with fold-over tag, 12 per case. Approx. case wgt. 62 lbs.

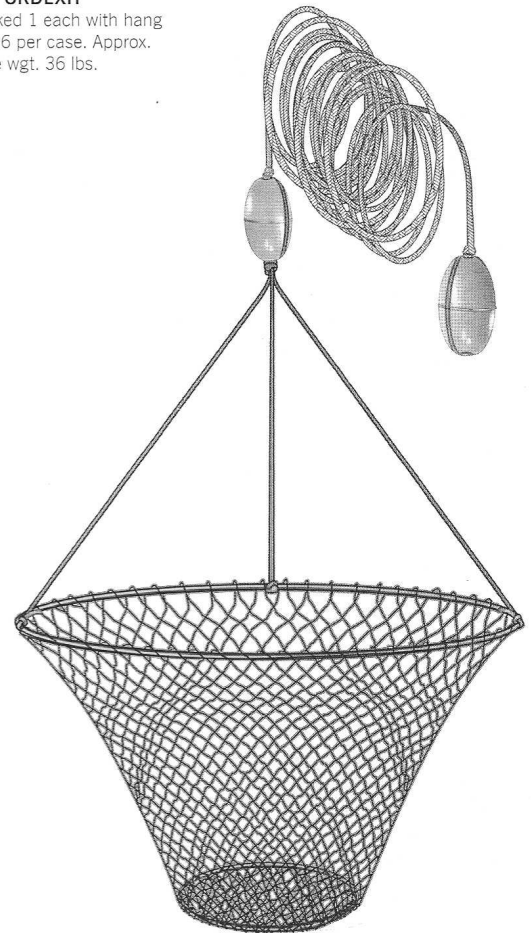

Jumbo Lobster and Crab Net with Harness & Rope

This fully rigged jumbo lobster and crab net features a braided-on rope harness, harness float, 100' of poly rope and a rope float. Vinyl-coated steel rod construction features a 36" upper ring and 14" lower ring and polypropylene netting measuring 20" in depth.

NO. LCRR

Packed 1 each with fold-over tag, 6 per case. Approx. case wgt. 45 lbs.

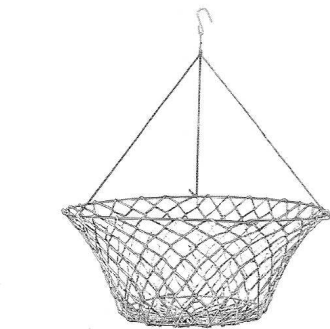

Double Ring Crab Net

This two-ring crab net uses an 18" upper ring and an 11" lower ring and features cotton netting. The 7" depth and tapered design prevents crabs from escaping during retrieval. Three-line cotton cord bridle and attachment hook are included.

NO. SR2

Packed 1 each with label, 120 per case. Approx. case wgt. 45 lbs.

Castable Crab Jaw

The Crab Jaw offers a unique, fun alternative to catch all types of crabs using a fishing pole. Bait ready, this spring-loaded trap cast in the closed position and springs open as it settles to the bottom. Keeping just a little slack in your line the bait post will signal your rod tip when crabs feed. As you quickly retrieve, the trap will close to secure your catch.

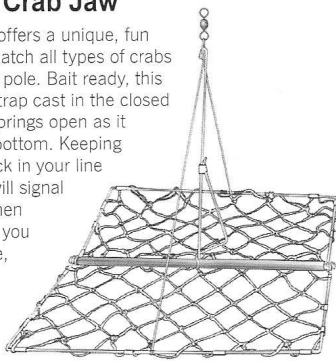

NO. CH1

Packed 1 each per polybag with fold-over header card, 12 per inner box, 48 per case. Approx. case wgt. 21 lbs.

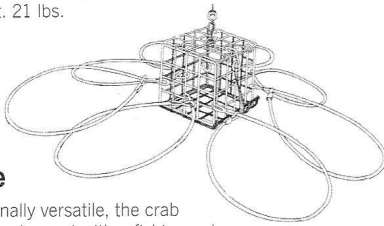

Crab Snare

Exceptionally versatile, the crab snare may be cast with a fishing rod and is a "go anywhere" small size. This vinyl-coated steel wire bait cage features a bottom opening door and 7 monofilament nylon snares. Top mounted swivel provides tangle free use.

NO. CSNR

Packed 1 each per display card, 12 per inner box, 120 per case. Approx. case wgt. 29 lbs.

Crab Throw Line

A seasonal best seller, this popular crab catching rig features a 25' cotton casting line and weighted bait pin.

NO. CTL

Packed 1 each per polybag with header card, 12 per inner box, 120 per case. Approx. case wgt. 16 lbs.



Star Crab Traps

These pyramid style traps are made of steel wire with a black enamel finish to resist saltwater corrosion. Each size is strung with poly take-up cords and ready for use. Star crab traps come fully collapsed in 12", 14" and 16" sizes.

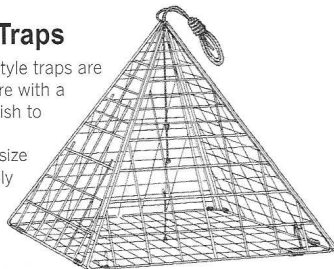

NO. JWB

Packed 1 each per printed polybag, 12 per case.

code	floor size	height	approx. case wgt.
12	12" x 12"	7-7/8"	16 lbs.
14	14" x 14"	9-3/8"	17 lbs.
16	16" x 16"	10-1/2"	22 lbs.

Vinyl-Coated Star Crab Trap

This rugged, 16" pyramid style crab trap has a protective vinyl coating over steel wire for longer life in saltwater. Already fully strung with tough poly take-up cords, this fully collapsible star trap is ready to use.

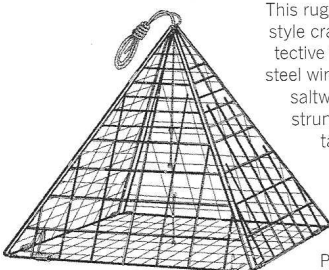

NO. JWB16VC

Packed 1 each per printed polybag, 12 per case. Approx. case wgt. 24 lbs.

Premium Crab Trap Harness

Designed for use with most crab traps and pots this premium harness features stainless steel ringed-eye marine snaps and extra heavy-duty crimps. Large end ring for mainline hook-up and four arm design work to secure trap during deployment and retrieval.



NO. CTH4SS

Packed 1 per polybag with header card, 12 per inner box, 72 per case. Approx. case wgt. 29 lbs.

Crab Trap Harness

Made to use with most crab traps and pots, this harness conveniently snaps on and off for easy hook-up and storage. It features a large end ring for mainline hook-ups, and the four arms secure the trap during deployment and retrieval. Made strong, its heavy-duty polyrope and nickel-plated steel hardware provide maximum protection against corrosion.



NO. FTCH

Packed 1 each per polybag with header card, 12 per inner box, 96 per case. Approx. case wgt. 40 lbs.

Crab Net Rope and Harness

This superb quality crab ring rope and harness has 50' of tough 3/8" polyrope and a bridle with three 40" arms. Designed to fit most crab ring nets, the bridle float keeps the bridle riding high above the bait. The surface float marks the location of the crab ring.



NO. CRH

Packed 1 each per polybag with header card, 12 per inner box, 60 per case. Approx. case wgt. 46 lbs.

Chum Bag

This chum bag features small mesh rot resistant netting designed to ensure that the bait will work longer. Extra long drawstring can be used to attach the bag to a crab trap. Rubber cord lock easily secures the bag shut. Bag measures 10" in diameter with a 10" opening and expands to 20" long.

NO. MCB

Packed 1 each with hang tag, 12 each per inner box, 144 per case. Approx. case wgt. 47 lbs.

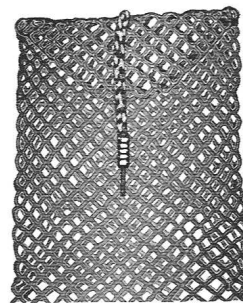

Mesh Bait Bag

Keep crab trap bait secure with this plastic mesh, envelope-type bait bag featuring one-piece construction with fold-over flap. Rubber strap and hook keep the flap closed and can be used to secure the bag to the trap. Measures 9-1/2" L x 8" W and will accept most commonly used baits.

NO. CTBB

Packed 1 each per polybag with insert label, 12 per inner box, 36 per case. Approx. case wgt. 11 lbs.

Bait Pin

Made of stainless steel wire this bait pin can be used with and secured to most crab traps. Simply open the pin, skewer the bait, attach to trap bottom and re-close the pin.

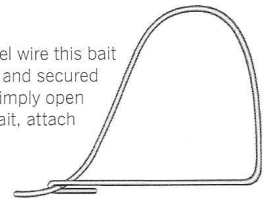

NO. CTBP

Packed 1 each per polybag with header card, 12 per inner box, 144 per case. Approx. case wgt. 13 lbs.

Small Mesh Bait Cage

This bait cage features a small mesh design to make it more difficult for crabs to get to the bait so it can work longer. Heavy-duty rubber band door closure can be used to secure cage to the trap floor. Constructed with vinyl coated steel wire it has a 6" x 4" opening and is 4-1/2" deep.

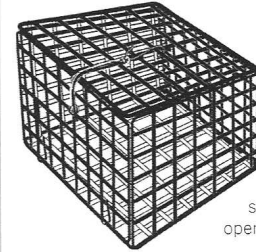

NO. CTBCS

Packed 1 each with fold-over tag, 24 per case. Approx. case wgt. 17 lbs.

Bait Cage

No bait, no catch. This bait cage keeps bait secure in larger crab traps. It features a heavy-duty rubber band door closure and tough vinyl-coated steel wire construction for longer life. Large enough to accept all commonly used baits, it measures 6" x 4" at the opening and is 8" deep.

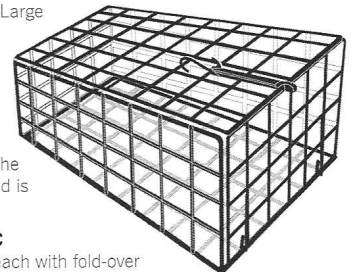

NO. CTBC

Packed 1 each with fold-over tag, 24 per case. Approx. case wgt. 13 lbs.

Bait Barrels

Engineered for crab and shrimp traps these bait barrels are proven both effective and convenient. Their cylindrical design features vinyl-coated wire mesh with plastic housing at both ends; one with an attachment snap and the other with a screw-on lid for filling with bait. Available in three sizes for most traps and baits.

NO. BCC

Packed 1 each with hang tag, 12 per inner box.

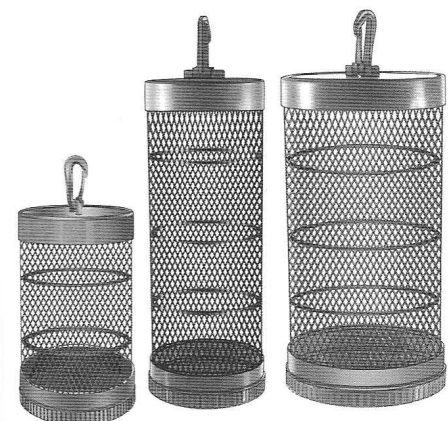

code	dimensions	each/ case	approx. case wgt.
N6	3-5/8" x 6"	48	17 lbs.
N9	3-5/8" x 9"	48	18 lbs.
W9	4-5/8" x 9"	24	14 lbs.

Crab Trap Gates

Prevent crabs from escaping by replacing old or damaged trap gates. Made of steel wire and vinyl-coated to prevent corrosion, these gates fit Pacific FTC crab traps.

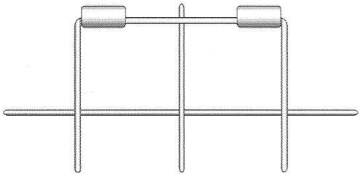

NO. FTCGSH

Packed 4 gates per polybag with header card, 12 bags per inner box, 60 per case. Approx. case wgt. 19 lbs.

Weighted Crab Trap Gates

Weighted to guarantee that they remain closed in heavy currents. Vinyl-coated to fight corrosion.

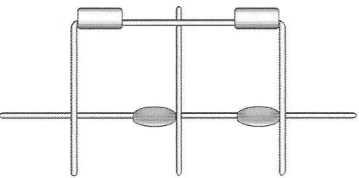

NO. FTCGSHW

Packed 4 gates per polybag with header card, 12 bags per inner box, 60 per case. Approx. case wgt. 50 lbs.

Octagon Crab Trap Hatch Strap

This replacement strap for the CTO4 and CTO3R octagon crab trap hatches comes assembled and ready to install. Remove strap to be replaced, then simply thread the rot-cord ends of the replacement strap through the bait cage hatch and fasten together with the wire crimps provided.



NO. CTODRS

Packed 1 each per polybag with header card, 12 per inner box, 144 per case. Approx. case wgt. 47 lbs.

Crab Trap Weights

Adding weight to your crab trap is easy, simply center weights on opposing sides at the floor and lock in with the 8" cable ties provided. Designed to fit most crab traps these 3-sided, 2-lb. weights are notched at both ends to ensure a secure fit.

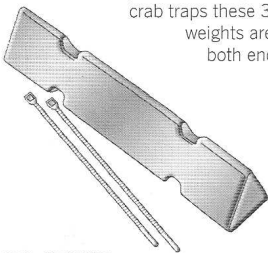

NO. CTWGT

Packed 1 pair per sealed polybag with stick-on label, 10 pair per case. Approx. case wgt. 42 lbs.

Line Snap

Unique design and spring action allow quick and easy on-off line snap application. Simply squeeze to open, hook around the line, then release to secure the stainless steel wire snap.



NO. LS

Packed 1 per polybag with header card, 12 per inner box, 144 per case. Approx. case wgt. 11 lbs.

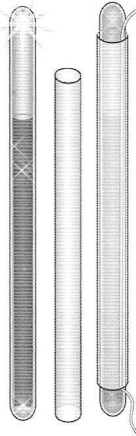

Light Sticks

A must have for deep water fishing, night fishing, or for an extra attractant. These light sticks require no batteries, flames, or heat, simply attach to your line, crack and cast.

NO. LSTK3

Individually packed 1 each per foil pouch, 3 pouches per polybag with header card, 12 cards per inner box, 600 per case. Approx. case wgt. 34 lbs.

Crab, Clam & Shrimp Gauge

This gauge is the quick and accurate way to measure your catch. Notched to measure crab shells at 5-3/4", 6" and 6-1/4", it also diagrams the gender for easy identification. A 1-1/2" ring makes it easy to verify the most commonly required minimum clam shell size. It also features a 1-3/16" shrimp carapace measure and a hole for attaching a lanyard.

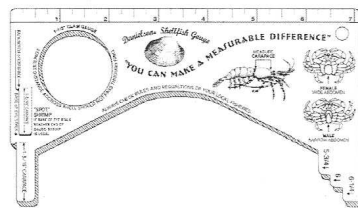

NO. 200CRG

Packed 1 per polybag with header card, 24 per inner box, 288 per case. Approx. case wgt. 26 lbs.

Braided Nylon Crab Trap Line

Braided for strength and flexibility, this 48' nylon line makes an excellent retrieval cord for star and ring type crab traps. This line is the preferred choice of serious crab fishermen because it won't rot and resists marine growth.



NO. CL48B

Packed 1 each per polybag with header card, 12 per inner box, 240 per case. Approx. case wgt. 32 lbs.

Crab Tongs

Avoid painful pinches or scalded fingers with our long-handled crab tongs. These 15" tongs safely remove crab from traps or cooking pots. And their black enamel finish resists corrosion.

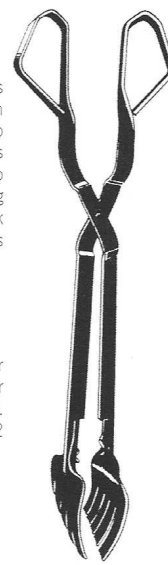

NO. 231CT

Packed 1 each per polybag with header card, 12 per case. Approx. case wgt. 12 lbs.

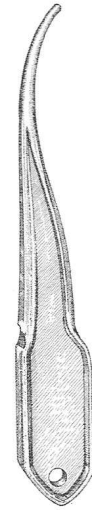

Shrimp Deveiner

Peels and cleans raw shrimp and crawfish in seconds with one easy thrust. Peeled and deveined shrimp cook faster with less odor and taste better. Easy to use and dishwasher safe.

NO. SDEV

Packed 1 per blister card, 12 per inner box, 240 per case. Approx. case wgt. 27 lbs.

Crab Line Weight

Used with crab trap retrieval lines, this weight keeps the floating polyrope directly under the surface float and out of the way of boats. The 12 ounce weight is securely connected to the crab line 10 to 15 feet below the float by a unique easy on, easy off stainless steel snap.

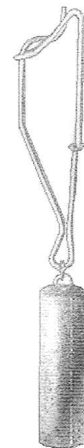

NO. CLWGT

Packed 1 each with stick-on label, 12 per inner box, 48 per case. Approx. case wgt. 41 lbs.



Crab Trap Line

For crab fishermen using a star or ring type crab trap, this 48' crab line makes an excellent retrieval cord. Made out of twisted polyrope, it won't rot and resists marine growth.

NO. CL48

Packed 1 each per polybag with header card, 24 per inner box, 240 per case. Approx. case wgt. 72 lbs.

Lead Core Rope

Lead core rope is engineered for marine applications where trap and mooring lines must remain under water and out of the way of boat propellers. Available in 75', 300' and 600' center pull coils this 5/16" diameter, twisted poly lead core rope is in yellow with a dark blue tracer.



NO. LCR75

Packed 1 each 75' coil in a heavy-duty polybag with header card, 12 per inner box, 24 per case. Approx. case wgt. 51 lbs.

NO. LCR300

Packed 4 each 300' center pull coils per case. Approx. case wgt. 36 lbs.

NO. LCR600

Packed 2 each 600' center pull coils per case. Approx. case wgt. 36 lbs.

Rope Float

Featuring a 1" diameter center hole this oval-shaped, general purpose rope float measures 3-1/2" in diameter by 5" in length.

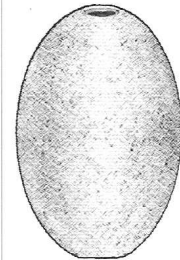

NO. RF5

Packed 1 each shrink-wrapped with label, 48 per case. Approx. case wgt. 10 lbs.

Red & White Crab Trap Float

Crabbers have no trouble locating their pots with these bright red and white floats. The high-density closed-cell foam design keeps crab lines afloat and works great as a boat moorage buoy or trot line marker. Each float measures 5-3/4" in diameter and 12-1/4" in length, with a centered 1" diameter hole for attaching the line.

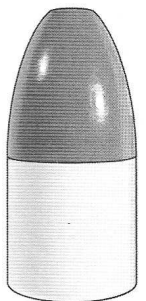

NO. CFRW

Packed 1 each with stick-on label, 24 per case. Approx. case wgt. 17 lbs.

Yellow Shrimp Trap Float

Designed for designation of shrimp pot locations these bright yellow floats work well in any situation where a buoy is required. Made of high-density closed cell foam each float measures 5-3/4" in diameter and 12-1/4" in length with a centered 1" hole for line attachment.

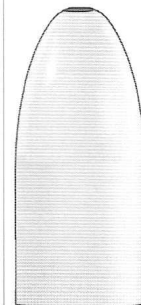

NO. SFY

Packed 1 each with stick-on label, 24 per case. Approx. case wgt. 17 lbs.

Crab Trap Float Set

Set includes red and white float for locating and identifying crab trap or ring. 50 feet of 1/4" poly retrieval rope and a line snap and weight for keeping the rope directly under the float and out of the way of boats.

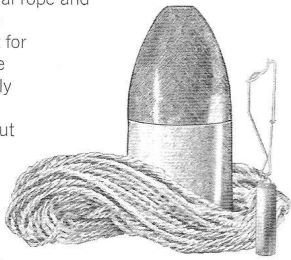

NO. CTFS

Packed 1 set per polybag with header card, 6 sets per case. Approx. case wgt. 35 lbs.

Crab Trap Float Set with Lead Core Rope

This float kit includes the deluxe red and white ABS float with luminous ring, 5/16" diameter lead core rope and premium crab trap harness.

NO. CTFLRH

Packed 1 set per polybag with header card, 6 sets per case.

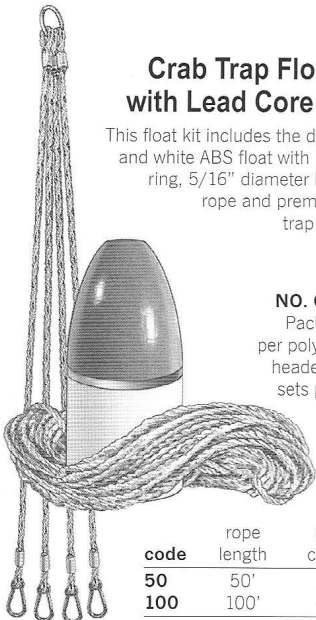

code	rope length	approx. case wgt.
50	50'	31 lbs.
100	100'	45 lbs.

Deluxe Red & White Crab Trap Float

Crabbers have no trouble locating their pots with these bright red and white floats which have a luminous band for low light situations. The ABS design keeps crab lines afloat and works great as a trot line marker. Each float measures 5-1/2" in diameter and 12-1/4" in length, with a centered 1" diameter hole for attaching the line.



NO. CFDLX

Packed 1 each with stick-on label, 24 per case. Approx. case wgt. 27 lbs.

Deluxe Yellow Shrimp Trap Float

Designed to locate your shrimp pot these bright yellow floats work well in any situation where a buoy is required. Made of high-density foam with a ABS plastic outside shell these floats measure 5-1/2" in diameter and 12-1/4" in length with a centered 1" hole for line attachment. The luminous ring allows you to see your float in any light situation.

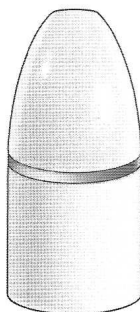

NO. SFDLX

Packed 1 each with stick-on label, 24 per case. Approx. case wgt. 17 lbs.

Clam Net

This unique clam net attaches to a belt, leaving hands free to gather your limit. It is made with a vinyl-coated steel ring and 21" deep nylon mesh netting.

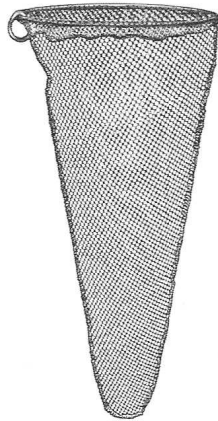

NO. 157

Packed 1 each with hang tag, 25 per inner box, 100 per case. Approx. case wgt. 35 lbs.

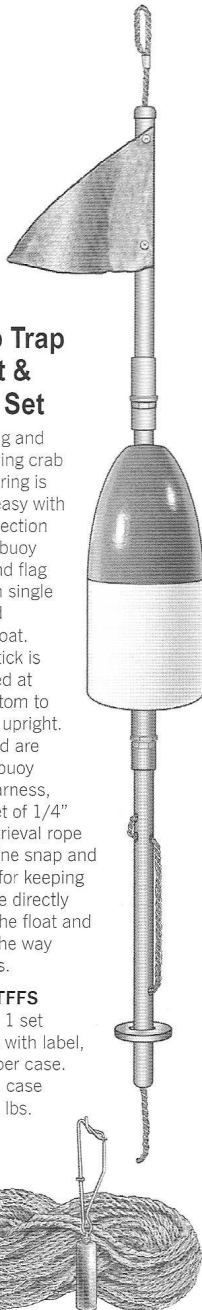

Crab Trap Float & Flag Set

Locating and identifying crab trap or ring is made easy with this 3-section plastic buoy stick and flag set with single red and white float. Buoy stick is weighted at the bottom to remain upright. Included are rigged buoy stick harness, 100 feet of 1/4" poly retrieval rope and a line snap and weight for keeping the rope directly under the float and out of the way of boats.

NO. CTFFS

Packed 1 set per box with label, 6 sets per case. Approx. case wgt. 31 lbs.

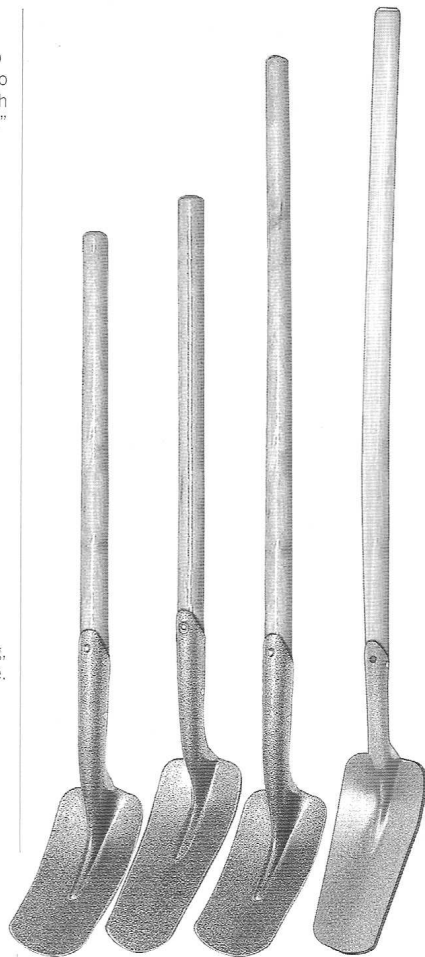
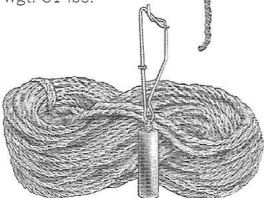

Clam Shovels

These exclusive shovels have been specifically engineered for clamming on sandy beaches. They feature forged steel blades and sockets, with premium grade hardwood handles for extra strength and durability. Specially angled blades give clam diggers extra leverage for better lift of heavy, wet sand.

NO. 269

Packed 1 each with stick-on label, 12 per bundle.

code	blade length	handle length	approx. case wgt.
9	9"	26"	27 lbs.
11	11"	26"	28 lbs.
941	9"	41"	35 lbs.
CS11LH	11"	41"	36 lbs.

Clam Rakes

Easy to transport and store with super strong, spring-loaded snaps to lock together the rake head and two sections of handle. Designed for digging, the 10 long sharp teeth and tough steel tube handle are enamel finished to resist corrosion. Available with or without basket.

NO. CRV (grate)

Packed 1 each with stick-on label, 3 per case. Approx. case wgt. 16 lbs.

NO. CRB (basket)

Packed 1 each with stick-on label, 3 per case. Approx. case wgt. 18 lbs.



Painted Steel Clam Gun

Engineered for taking razor clams from sandy ocean beaches this enamel finished, welded steel clam gun is time tested and success proven. Measuring 31" in length it features a 5" x 15" barrel with 1-3/16" x 10" T-handle.

NO. 279T

Packed 1 each with stick-on label, 6 per case. Approx. case wgt. 29 lbs.

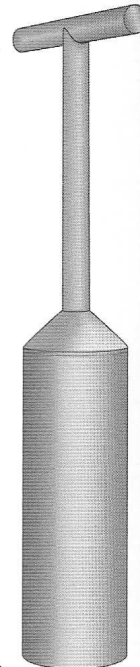

Anodized Aluminum Clam Gun

Ultra-light welded aluminum construction makes clamming less of a workout. Engineered for taking razor clams from sandy ocean beaches this corrosion resistant clam gun is time tested and success proven. Measuring 31" in length it features a 5" x 15" barrel with 1-3/16" x 10" T-handle.

NO. CGAA

Packed 1 each with stick-on label, 6 per case. Approx. case wgt. 18 lbs.

Stainless Steel Clam Gun

This durable and corrosion resistant stainless steel clam gun is engineered for taking razor clams from sandy ocean beaches. With time tested and success proven design it measures 31" in length and it features a 5" x 15" barrel with 1-3/16" x 10" T-handle.

NO. CGSS

Packed 1 each with stick-on label, 6 per case. Approx. case wgt. 31 lbs.

